

# User Guide



RADIO MICROPHONE SYSTEMS

*Sound Designed*

The RMS 2020 System is noted for its ease of use. If however you need advice or technical support at any time please contact Audio Ltd.

All products come with free lifetime technical support, and we are also always pleased to help users of our equipment, whatever the application.

Audio Ltd,  
Audio House  
Progress Road  
High Wycombe  
Bucks, HP12 4JD  
U.K.

Tel: +44 (0)1494 511711

Fax: +44 (0)1494 539600

email: [info@audioltd.com](mailto:info@audioltd.com)

World Wide Web: <http://www.audioltd.com>

Copyright © 1999 Audio Limited

Part no: RMS 2020U/1

This guide was produced by  
Human Computer Interface Limited,  
<http://www.interface.co.uk>

# Contents

---

<b>Introduction</b>	<b>4</b>
The RMS 2020 System .....	4
Diversity reception .....	6
Selecting frequencies .....	6
<b>DX 2020 Receiver</b>	<b>7</b>
Controls, displays, and connections .....	7
Setting up the DX 2020 .....	8
Technical specification .....	10
<b>TX 2020 Pocket Transmitter</b>	<b>11</b>
Controls, displays, and connections .....	11
Setting up the TX 2020 .....	12
Technical specification .....	13
<b>HX 2000 Hand Held Transmitter</b>	<b>14</b>
Controls, displays, and connections .....	14
Setting up the HX 2000 .....	15
Holding the HX 2000 .....	16
Technical specification .....	17
<b>RK 2 Minirack</b>	<b>18</b>
Controls, displays, and connections .....	18
Setting up the RK 2 .....	19
Setting the output phase .....	20
Technical specification .....	20
<b>DK 2000 Rack</b>	<b>21</b>
Controls, displays, and connections .....	21
Setting up the DK 2000 .....	23
Audio monitoring .....	24
Bargraph display .....	24
Technical specification .....	24
<b>Troubleshooting</b>	<b>25</b>
<b>Cable wiring diagrams</b>	<b>27</b>
<b>Index</b>	<b>30</b>

# Introduction

---

**This chapter gives a general introduction to radio microphones, and shows how the RMS 2020 Series products interrelate.**

## Audio Limited

---

Audio Limited has been designing and manufacturing broadcast quality radio microphone systems for over thirty-five years and over this period they have become the choice of professional sound mixers around the world.

Audio Limited's systems have acquired an acclaimed reputation for reliability and transparent sound quality through our commitment to designing products with maximum input from the customer.

All products designed by Audio Limited are a result of listening to our customers.

## The RMS 2020 System

---

The RMS 2020 is a 32-channel synthesised diversity radio microphone system designed to give extremely clear sound combined with world wide compatibility.

The illustration opposite shows the products in the RMS 2020 System.

### **TX 2020**

The small battery-powered pocket transmitter for use with a range of lapel microphones.

### **HX 2000**

A hand-held transmitter for use with a range of high-quality Schoeps microphone capsules.

### **DX 2020**

The diversity receiver in the RMS 2020 System, it can be used as a portable receiver, with a camcorder, or mounted in an RK 2 or DK 2000 rack.

### **RK 2 Minirack**

Allows two DX 2020 receivers to be mounted in a compact portable rack.

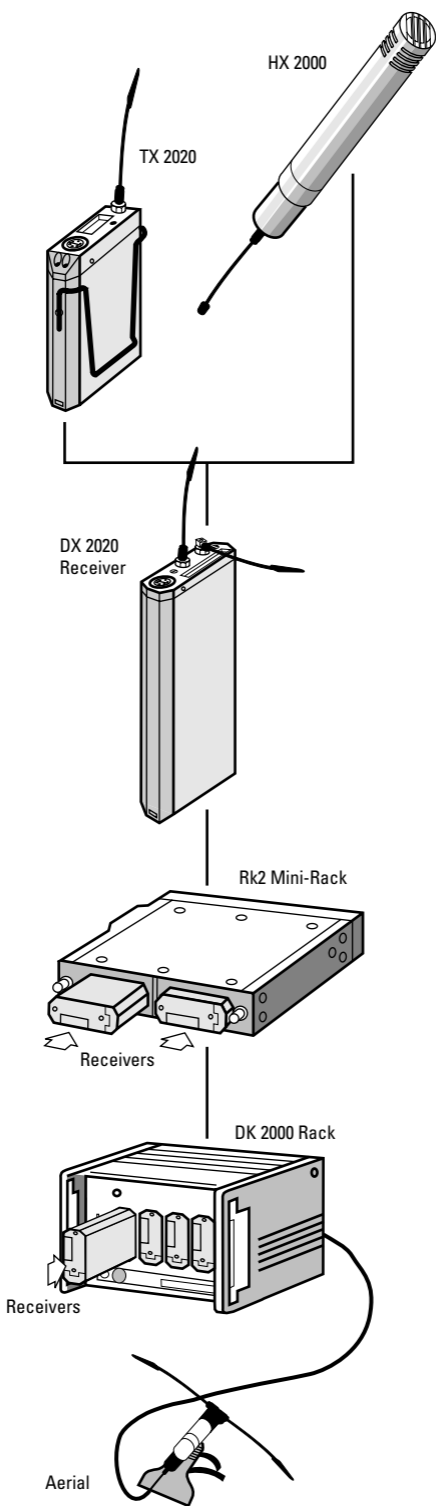

**DK 2000 Rack**

Allows up to four DX 200 receivers to be mounted and powered in a portable rack, with visual and headphone monitoring.

All the UHF products from the RMS 2000 range are directly compatible with the RMS 2020 range.

## Diversity reception

---

When electromagnetic waves are radiated by a moving transmitter, the receiver picks up reflected signals from surrounding structures as well as the directly radiated signal. These reflected signals combine with the direct signal, and in the case where the combining signals are out of phase with each other, a drop-out or loss of signal results.

To eliminate this cancellation effect Audio Limited employ the true diversity technique in the DX 2020 receiver.

The DX 2020 receiver incorporates two separate receivers fed by separate antennae. A comparator circuit compares the RF levels from the two receivers ensuring that the receiver will always switch to the strongest signal. A noiseless switching circuit takes full advantage of the accurate level detection to allow switching as often as needed without noise or clicks. The result is a reliable, dropout free, broadcast-quality audio signal indistinguishable from a line microphone.

## Selecting frequencies

---

The RMS 2020 System provides a choice of 32 operating frequencies, in two banks in the UHF 470MHz to 1000MHz range. This gives the flexibility of allowing several sets of receivers and transmitters to be operated in the same area without interference.

# DX 2020 Receiver

The DX 2020 diversity receiver in the RMS 2020 range can be used, in conjunction with a TX 2020 or HX 2000 transmitter. Alternatively, up to four DX 2020 receivers can be rack mounted for applications where multiple wireless microphone systems are required.

## Controls, displays, and connections

### Bottom panel

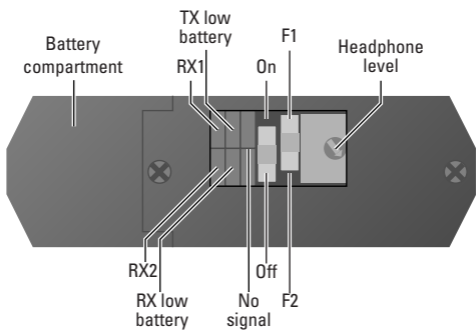

### Batteries

Holds three DL123A 3 volt Lithium batteries.

### RX1/RX2 indicators

Indicate which of the unit's two built-in receivers is active at any time.

### TX/RX low battery indicators

Illuminate when the unit detects low battery power in either the TX 2020 Pocket Transmitter or DX 2020 Receiver. The units should not be used when a low battery power indicator is illuminated as poor operation may result.

### No-signal indicators

Illuminated when no carrier signal is being received, such as when the transmitter is switched off or set to an incorrect frequency.

### On/Off

Switches the power on or off. Additionally the output cable includes a link which disconnects power when the Lemo plug is removed, in which case the switch can be left on.

## F1/F2

Selects between the two banks of 16 frequencies; see *Selecting the operating frequency*, page 9.

## Headphone level

Adjusts the headphone level output. Use a small screwdriver to turn the control.

## Top panel

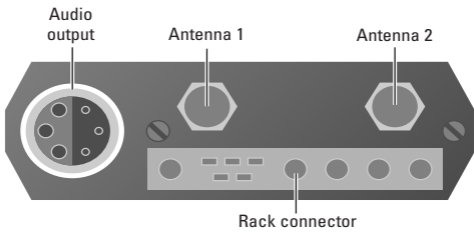

## Audio output

Provides balanced microphone level and adjustable headphone outputs.

## Antenna 1/Antenna 2

SMA sockets to which the antennae are connected.

## Rack connector

The multiway connector is for use with the DK 2000 and the RK 2 rack systems.

# Setting up the DX 2020

---

To set up the DX 2020 in conjunction with a TX 2020 or HX 2000:

- Fit the batteries.
- Set the transmitter and receiver to the same operating frequency.
- Connect the RX1 and RX2 antennae.
- Switch on.
- Connect the audio output cable.
- Check that one of the RX1 and RX2 indicators is illuminated, and that the 'No signal' indicators are not illuminated.

These steps are explained below:

## Fitting the batteries

To open the battery compartment, press the release button and flip the cap. Insert three DL123A 3 volt Lithium batteries, negative contact first as shown on the side of the unit, and close the cover. Do not use excessive force.



### Selecting the operating frequency

Select the operating frequency you want to use from the label on the side of the DX 2020. Set the F1/F2 switch to F1 (first column of frequencies) or F2 (second column of frequencies). Rotate the switch on the side of the DX 2020 using a small screwdriver to select the frequency, 1 to 16.

Switch the DX 2020 off and back on again to enable the change in frequency.

### Connecting the antennae

Connect the antennae to the SMA connectors marked RX1 and RX2. Connect the straight antenna to one socket and the right-angled antenna to the other socket.

### Indicators during correct operation

The DX 2020 should switch between the RX1 and RX2 receivers for best reception, as indicated by the RX1 and RX2 indicators:

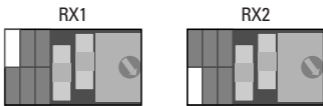

The 'No signal' indicators will not be lit if the corresponding TX 2020 transmitter is on.

### External powering

If the DX 2020 receiver is to be externally powered, ensure that the appropriate cable is used.

## Technical specification

---

<b>Size</b>	147 x 64 x 20mm
<b>Weight</b>	250g
<b>Temperature range</b>	-20°C to +55°C
<b>Frequency range</b>	470MHz–1000MHz
<b>Number of frequencies</b>	32
<b>Balanced output level</b>	-26dBm
<b>Batteries</b>	3 x 3V DL123A Lithium
<b>Battery life</b>	Approximately 10 hours
<b>External power</b>	9–14V DC via 6-pin Lemo™ socket
	Certified

# TX 2020 Pocket Transmitter

The TX 2020 Transmitter is a small, lightweight, battery-powered pocket transmitter for use with a wide range of lapel microphones.

Controls, displays, and connections

## Top panel

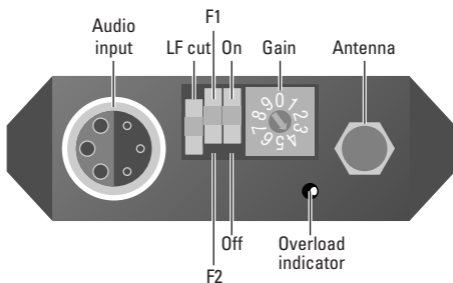

### Audio input

Allows a microphone or line-level input to be connected.

### LF cut

Gives approximately 6dB LF cut at 50Hz, to assist in the reduction of wind noise.

### F1/F2

Selects between the two banks of 16 frequencies; see *Selecting the operating frequency*, page 9.

### On/Off

Switches the power on or off. Additionally the microphone cable includes a link which disconnects power when the Lemo plug is removed, in which case the switch can be left on.

### Gain

Provides eight gain options when used with standard microphones. 0 gives minimum gain, and each position increases the gain by approximately 4dB giving a total of 30dB of adjustment. Position 8 and 9 provide line level input to 600Ω impedance.

### Overload indicator

Indicates the low distortion overload limiter is operating.

## Setting up the TX 2020

---

To set up the TX 2020 in conjunction with a DX 2020:

- Fit the battery.
- Set the transmitter and receiver to the same operating frequency.
- Connect the antenna.
- Switch on.
- Connect the microphone.
- Check that the receiver's 'No signal' indicators are not illuminated.
- Set the microphone gain.

These steps are explained below:

### **Fitting the battery**

To open the battery compartment press the release buttons at each end of the battery tray and slide out the tray. Insert a 6LR61 type 9 volt alkaline battery, observing the polarity as shown on the inside of the tray, and replace the tray. Do not use excessive force.

An electronic resettable fuse protects the transmitter from reverse powering. A low transmitter battery indicator is provided on the DX 2020 Receiver.

### **Selecting the operating frequency**

Select the operating frequency you want to use from the label on the side of the TX 2020. Set the F1/F2 switch to F1 (first column of frequencies) or F2 (second column of frequencies). Rotate the switch inside the TX 2020 battery compartment using a small screwdriver to select the frequency, 1 to 16.

Switch the TX 2020 off and back on again to enable the change in frequency.

### **Connecting the antenna**

Connect the flexible antenna to the SMA connector.

### **Connecting the audio input**

Connect the microphone or line level input to the six-pin Lemo connector. Both positive and negative bias voltages are provided, enabling the majority of lavalier microphones to be used with the TX 2020.

### Setting the microphone gain

The microphone gain control should be adjusted to suit your particular requirements. Select the gain position such that the overload indicators do not illuminate during normal speech.

## Technical specification

---

<b>Size</b>	87 x 60 x 21mm
<b>Weight</b>	115g
<b>Temperature range</b>	-20°C to +55°C
<b>Frequency range</b>	470MHz–1000MHz
<b>Frequency stability</b>	Better than ETS 300–422
<b>Number of frequencies</b>	32
<b>Output power</b>	50mW nominal
<b>Gain control range</b>	30dB in 8 steps, plus 2 steps for 600Ω line input
<b>Maximum input level</b>	-6dBm (position 7) +6dBm (position 8, 600Ω)
<b>Frequency response</b>	50Hz to 15kHz ±1dB
<b>THD</b>	<0.1% at working levels <0.3% at gain position 7 with -6dB input in overload
<b>Battery</b>	1 x 9V 6LR61 Alkaline
<b>Battery life</b>	More than 6 hours.
	Certificate No. 13148

# HX 2000 Hand Held Transmitter

The HX 2000 is a hand held transmitter for use with the DX 2020 diversity receiver. It provides two switchable frequencies, and can be used with a range of microphone capsules from the Schoeps Colette series.

## Controls, displays, and connections

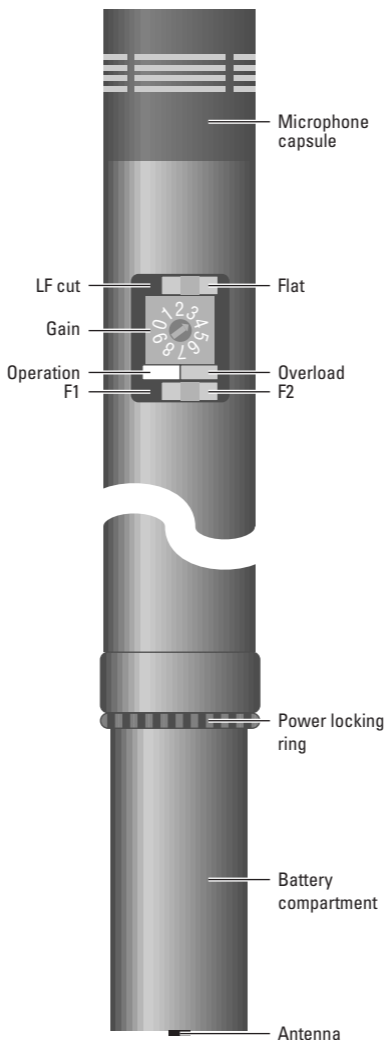

### Microphone capsule

Compatible with the full range of capsules and accessories in the Schoeps Colette range.

### LF cut

Gives approximately 3dB LF cut at 100Hz and an additional 6dB per octave below this, to assist in the

reduction of wind noise.

### **Gain**

Provides ten gain options; 0 gives minimum gain, and each position increases the gain by approximately 4dB giving a total of 40dB of adjustment.

### **Operation indicator**

Indicates amber when the unit is on and the battery voltage is within the working range. The indicator will go out when the battery voltage is low; although the HX 2000 will continue to operate for a short time after this, the battery should be replaced as soon as possible.

### **Overload indicator**

Indicates that the low-distortion overload limiter is operating.

### **F1/F2**

Selects between the two available operating frequencies; see *Selecting the operating frequency* below.

### **Power locking ring**

Locks the battery compartment to prevent accidental switching off while in use.

### **Battery compartment**

Holds one DL123A 3 volt Lithium battery.

### **Antenna**

The optional antenna screws in the base of the battery compartment.

## Setting up the HX 2000

---

To set up the HX 2000 in conjunction with a DX 2020:

- Fit the battery.
- Set the transmitter and receiver to the same operating frequency.
- Connect the antenna (optional).
- Switch on by turning the battery compartment until the operation indicator lights up.
- Lock into position with the locking ring.
- Set the gain.
- Check that the receiver's 'No signal' indicators are not illuminated.

These steps are explained below:

### **Fitting the battery**

Unscrew the battery compartment and insert a DL123A type Lithium battery with the positive end uppermost. Replace the battery compartment.

### **Selecting the operating frequency**

Set the F1/F2 switch to select the operating frequency. The two available operating frequencies are marked on the label above the battery compartment.

### **Connecting the antenna**

Screw the antenna directly into the base of the battery compartment. For short-range work the antenna can be omitted, as the battery compartment acts as an antenna.

### **Switching on**

To switch on unscrew the locking ring, and then screw the battery compartment up tight so that the amber operation indicator lights up. Then screw up the locking ring to prevent the user from inadvertently unscrewing the battery compartment during use.

When not in use the power should be locked off by unscrewing the battery compartment and then tightening the locking ring. Remove the battery if the unit is not to be used for a while.

### **Setting the gain**

The gain control should be adjusted to suit your particular requirements. Select the gain position such that the overload indicator does not illuminate during normal speech.

## ..... Holding the HX 2000

The HX 2000 should be held by the main tube, which is finished in gloss black to minimise handling noise.

Avoid touching the areas finished in matt black, and in particular the battery compartment as this forms part of the antenna.

The HX 2000 handheld transmitter does not transmit the low TX battery level, consequently the low TX battery indicator on the receiver will remain on. This is not a fault.



HX 2000 Hand Held  
Transmitter

---

## Technical specification

---

<b>Length</b>	220mm including capsule
<b>Diameter</b>	20mm reducing to 18mm at base
<b>Weight</b>	130g
<b>Temperature range</b>	-20°C to +55°C
<b>Frequency range</b>	140MHz–1000MHz
<b>Number of switchable frequencies</b>	2
<b>Output power</b>	10mW nominal
<b>Gain control range</b>	40dB in 10 steps
<b>Frequency response</b>	50Hz to 15kHz $\pm$ 1dB excluding capsule
<b>THD</b>	<0.3% at 1kHz in overload
<b>Battery</b>	3V DL123A Lithium
<b>Battery life</b>	Approximately 6 hours
<b>CE</b>	Certificate No. 11985

# RK 2 Minirack

---

The RK 2 Minirack allows you to mount two DX 2020 or DX 2000 diversity receivers in one portable unit. It includes a built-in active distribution amplifier, with approximately 3dB of gain, to allow up to two receivers to be fed from a single pair of antennae mounted on the rack. The RK 2 uses the same antennae as the individual receivers.

## Controls, displays, and connections

---

### Side panel

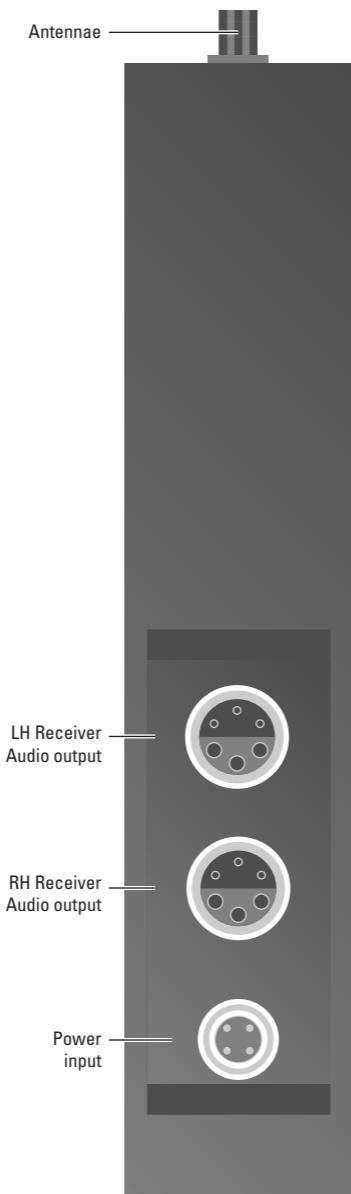

### **Audio output**

Provides microphone-level balanced outputs from the two receivers.

### **Power input**

Allows the receivers to be powered via an external DC supply.

### **Antennae**

Connects the Rx1 and Rx2 antennae.

### **Front panel**

The indicators and controls of each receiver are visible from the top of the RK 2 rack. For more information see *DX 2020 Receiver*, page 7.

## Setting up the RK 2

---

To set up the RK 2 in conjunction with one or two DX 2020 receivers:

- Fit the receivers into the RK 2.
- Connect external power.
- Connect the antennae.

These steps are explained below:

### **Fitting the receivers**

To fit the individual receivers into the RK 2 first remove the plastic plate covering the multipin connector on each receiver. Orientate the receiver to ensure correct alignment of the Lemo and multipin connectors. Slide the receiver in, and push firmly home. Do not use excessive force.

### **Connecting power**

Connect power to the four-pin Hirose connector via the cable provided (900–122). Alternatively the RK 2 can be powered via either of the six-pin Lemo connectors.

The RK 2 has a built-in regulator and can accept power in the range 9–15V DC. It is over voltage and reverse power protected; if reverse power is accidentally applied disconnect the supply and allow a few moments for the electronic fuse to reset.

## Connecting the antennae

Connect the antennae to the SMA sockets marked Rx1 and Rx2 on the front panel. Connect the straight antenna to one socket and the right-angled antenna to the other socket.

## Setting the output phase

The RK 2 is factory set to provide outputs of the same phase as the individual receivers. Should opposite phase be required reset the DIP switch positions as shown in the following diagrams:



## Technical specification

<b>Size</b>	168mm (+12mm connector block) x 151mm x 30mm
<b>Weight</b>	650g
<b>Frequency range</b>	To order
<b>Gain</b>	Typically 2–4dB across range
<b>Power</b>	9–15V at 80mA plus 140mA per receiver, with reverse power and over voltage protection up to 30V.

# DK 2000 Rack

The DK 2000 Rack System allows up to four DX 2020 or DX 2000 diversity receivers to be mounted and powered in a single portable unit. A built-in distribution amplifier allows a single pair of antennae to be used.

The DK 2000 allows you to monitor the RF level of any receiver and display the signal strength on LED bargraphs. Bargraphs also give a continuous readout of the selected receiver's audio level and transmitter battery voltage.

In addition, the outputs from any combination of the four receivers can be monitored through headphones.

The DK 2000 can be powered from internal batteries, or from an external DC power source.

## Controls, displays, and connections

### Front panel

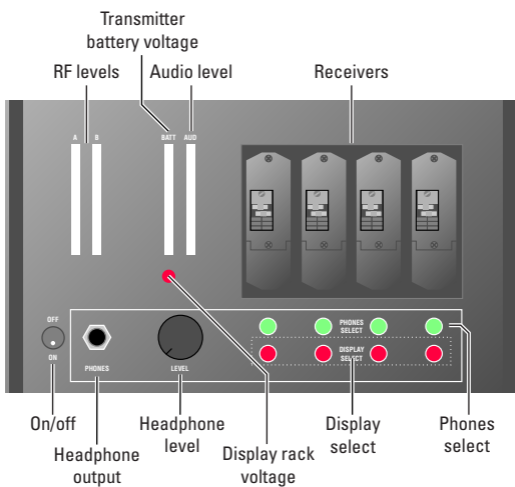

### RF Level bargraphs

Displays the RX1 and RX2 RF levels for the selected receiver.

### Transmitter battery voltage bargraph

Displays the transmitter battery voltage for the selected receiver.

### Audio level bargraph

Displays the audio output level from the selected receiver.

### Headphone output

Allows any combination of receivers to be monitored via a standard  $\frac{1}{4}$ " stereo jack socket (wired as mono).

### On/off switch

Switch the toggle switch to the down position to turn the DK 2000 on, and up to turn the unit off.

### Headphone level

Adjusts the overall output level of the mixed headphone signal.

### Audio monitor select switches

Selects which of receivers are monitored via the headphone output.

### Display select switches

Selects which of the receivers is monitored via the four LED bargraph displays.

### Rack battery voltage switch

Press to monitor the DK 2000's own battery voltage on the battery LED bargraph.

### Rear panel

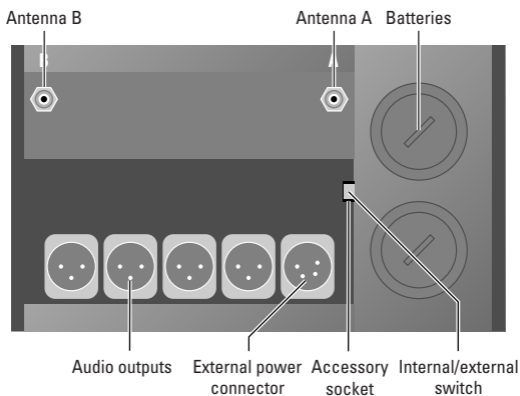

### Audio outputs

Provides standard XLR connections with balanced microphone level outputs.

### Antennae

Two BNC connectors for the antenna inputs.

### Batteries

Insert six D cells negative end first.

### External power connector

The DK 2000 can be powered from an external supply of 9 to 14V DC through the four-pin XLR socket.

### **Internal/External switch**

Switch the toggle switch to the down position to select internal power, and to the up position for external power.

### **Accessory socket**

A four-pin Hirose socket allows accessories such as an RK 2 or individual receivers to be powered from the DK 2000 via appropriate cables.

## Setting up the DK 2000

---

To set up the DK 2000 in conjunction with up to four DX 2020 receivers:

- Fit the receivers into the DK 2000.
- Fit the batteries or connect external power.
- Connect the antennae.

These steps are explained below:

### **Fitting the receivers**

To fit the individual receivers into the DK 2000 first remove the plastic plate covering the multipin connector on each receiver. Slide the receiver in, and push firmly home. Do not use excessive force.

### **Fitting the batteries**

The DK 2000 can be powered by six D-type cells. The batteries should be inserted negative terminal first.

### **Connecting power**

Alternatively connect power to the four-pin XLR connector; pin 1 is ground and pin 4 +DC. The DK 2000 can accept power in the range 9–14V DC. It is over voltage and reverse power protected.

### **Connecting the antennae**

Connect the antennae to the BNC sockets marked A and B on the back panel.

Masthead amplifiers are available to allow the use of long aerial cable lengths with phantom powering directly from the antenna inputs. A variety of antenna types can also be supplied to suit specific applications.

## Audio monitoring

To monitor the mixed outputs of selected receivers connect a pair of headphones to the headphone output, and press the green PHONES SELECT switches for each receiver to be monitored. The selected switches will illuminate to show which receivers are being monitored.

Adjust the level using the headphone level control.

## Bargraph display

To monitor a receiver's RF levels, transmitter battery voltage, and audio level on the four LED bargraphs press the red DISPLAY SELECT switch. The switch will illuminate to show which receiver is being monitored.

To display the DK 2000 battery voltage on the BATT LED bargraph press and hold the red button below the bargraph. Release the button to switch back to displaying transmitter battery voltage.

## Technical specification

<b>Size</b>	3 U high, half rack width 234 x 132 x 295mm
<b>Weight</b>	3.5kg (excluding batteries)
<b>Batteries</b>	6 D-type cells.
<b>Battery life</b>	4 hours typical.
<b>External power</b>	9–14V DC



# Troubleshooting

---

This chapter provides step-by-step troubleshooting procedures for any combination of RMS 2020 System products.

Experience has shown that the majority of problems are due to bad batteries, faulty antennae, and faulty cables, as these items are most susceptible to damage. Please check these items first, and check that the LED indicators are correct, before proceeding further.

## DX 2020

---

### **No signal indicator illuminating on the receiver**

- Check that the batteries are good and correctly inserted.

## TX 2020

---

- Check that the transmitter overload indicator flashes when plugging in the mic.
- Check that the frequencies on the transmitter and receiver match.
- If the frequency has been changed check that the transmitter and receiver were both turned off and then back on to enable the change.

## HX 2000

---

- Check that the frequencies on the hand-held transmitter and receiver match.

### **No audio output**

Assuming all indicators are functioning correctly:

- Check that the mic gain setting is in the correct position for application (positions 8 and 9 on the mic gain setting are for line input only).
- Check that the microphone is working. Shout into the mic at mic gain setting 7, and check that the overload indicator flashes.
- Check the output cables.

## RK 2 Minirack and DK 2000 Rack

---

### **Receivers not functioning in the rack**

- Check that the receivers are pushed firmly home.
- Check that the receiver functions out of the rack.
- Check powering to the rack.

### **Low range**

- Check the antennae.
- Check whether there are any interfering signals in your local environment.

# Cable wiring diagrams

---

## Transmitter line/microphone input cable (900-018)

---

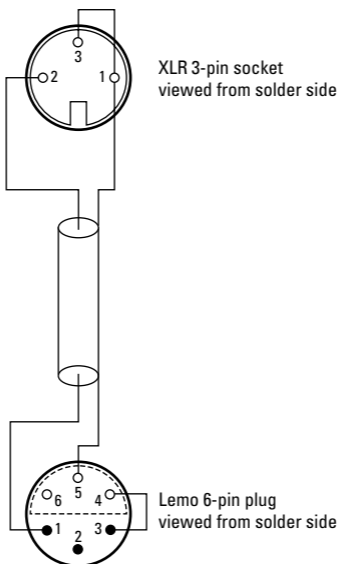

## Receiver/RK 2 output cable (101-490)

---

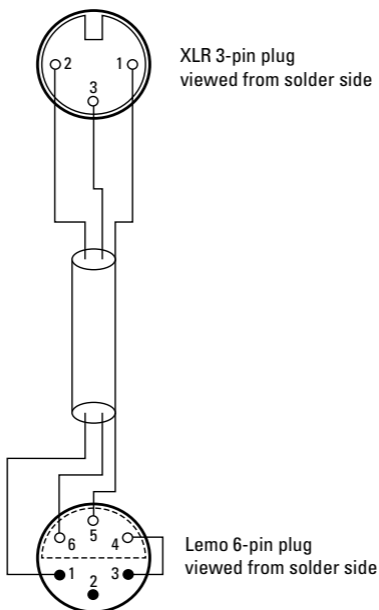

## Receiver/RK 2 output and Betacam power cable (900-016)

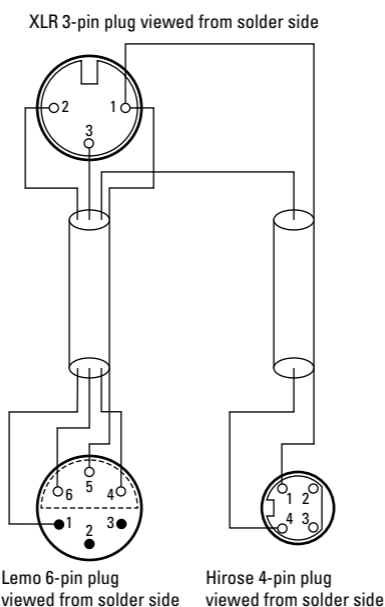

## Receiver/RK 2 output and mixer power cable (900-017)

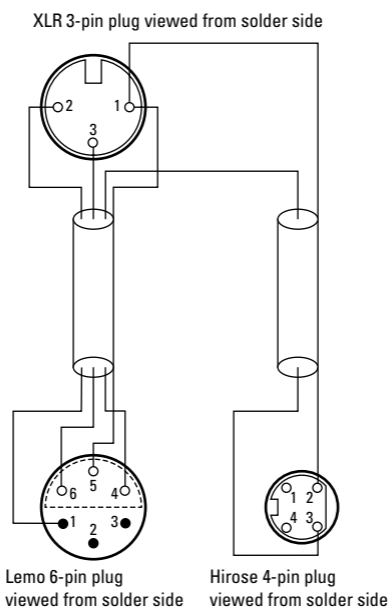

## Headphone output cable (900-063)

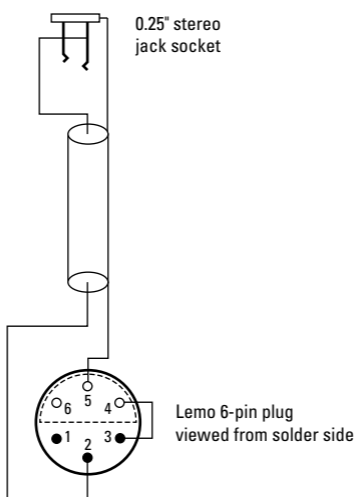

## Microphone wiring for TX 2020

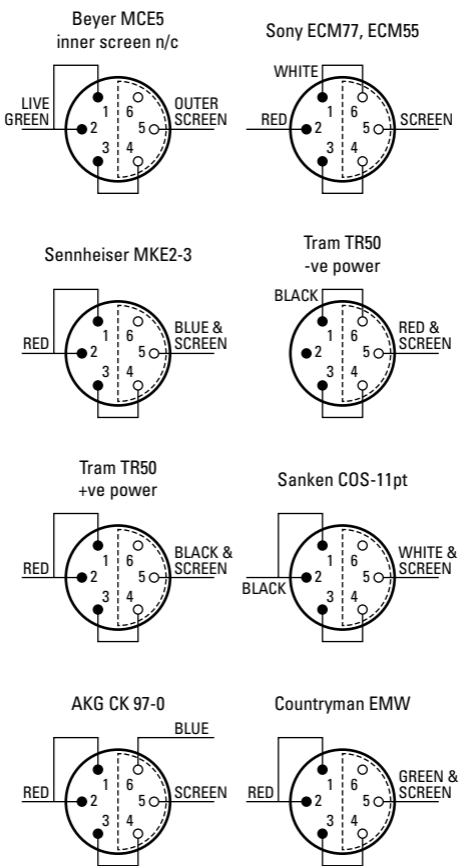

Plugs are viewed from the solder side

# Index

---

## C

**cable wiring diagrams 27**

## D

**diversity reception 6**

**DK 2000 Rack 4, 21**

audio monitoring 24

bargraph display 24

connecting power 23

connecting the antennae 23

controls, displays, and connections 21

fitting the batteries 23

fitting the receivers 23

front panel 21

rear panel 22

setting up 23

technical specification 24

**DX 2020 Receiver 4, 7**

bottom panel 7

connecting the antennae 9

controls, displays, and connections 7

external powering 9

fitting the batteries 8

indicators during correct operation 9

setting the operating frequency 9

setting up 8

technical specification 10

top panel 8

## F

**frequencies, selecting 6**

## H

**HX 2000 Hand Held Transmitter 4, 14**

connecting the antenna 16

controls, displays, and connections 14

**HX 2000 Hand Held Transmitter (continued)**

- fitting the battery 16
- handling 16
- selecting the operating frequency 16
- setting the gain 16
- setting up 15
- switching on 16
- technical specification 17



**microphone wiring diagrams 29**



**RK 2 Minirack 4, 18**

- cable wiring diagrams 27
- connecting power 19
- connecting the antennae 20
- controls, displays, and connections 18
- fitting the receivers 19
- front panel 19
- setting up 19
- side panel 18

**RMS 2020 System 4**



**technical specification**

- DK 2000 Rack 24
- DX 2020 Receiver 10
- HX 2000 Hand Held Transmitter 17
- TX 2020 Pocket Transmitter 13

**troubleshooting 25**

**TX 2020 Pocket Transmitter 4, 11**

- connecting the antenna 12
- connecting the audio input 12
- controls, displays, and connections 11
- fitting the battery 12
- selecting the operating frequency 12
- setting the microphone gain 13
- setting up 12
- technical specification 13
- top panel 11