

NAGRA ARES-M USER MANUAL



Software version
V3.18 Build 0724
July 26, 2007

1	GUARANTEE	5
2	DELIVERED WITH	6
	3.1 Front panel key functions.....	7
	3.2 Left side key functions.....	8
	3.3 Right side	8
	3.4 Top face.....	9
	3.5 Bottom face.....	9
4	INSTALLING BATTERIES	9
5	FIRST POWER ON.....	9
6	RECORD WINDOW DESCRIPTION	10
	6.1 Display name	10
	6.2 Input name	10
	6.3 Record level	10
	6.4 Filter status	10
	6.5 AGC status.....	10
	6.6 Output volume	10
	6.7 VOR status	11
	6.8 Modulometer.....	11
	6.9 Play / Record file name	11
	6.10 Play / Record time	11
	6.11 Play progress & free disk space bar (3 colour)	11
	6.12 Total file / Free record time.....	11
	6.13 File counters	11
	6.14 Run status	11
	6.15 Audio parameters.....	11
	6.16 USB status	11
	6.17 Keyboard status	11
	6.18 Battery status.....	11
7	USING THE ARES-M	12
	7.1 Recording audio in the field	12
	7.1.1 The Automatic Gain Control (A.G.C).....	13
	7.2 Voice Operated Recording	13
	7.3 Playback of a previous recording.....	13
	7.3.1 Adjusting playback levels	14
	7.4 Storing settings in a template	14
	7.5 Deleting an audio recording rapidly	14
8	MENUS	14
	8.1 Menu Tree.....	15
	8.2 Set input device.....	15
	8.3 Set compress template	15
	8.4 Set VOR mode.....	15
	8.5. Set VOR stop mode.....	16
	8.6 Set VOR stop delay	16
	8.7 Set the pre-rec buffer	16
	8.8 Setting the loop mode.....	16
	8.9 Setting the search speed	16
	8.10 Setting the input matrix	16
	8.11 Setting the work directory	16
9	FILE / FOLDER MANAGER	17
	9.1 Renaming	17
	9.1.1 Renaming a directory	17
	9.1.2 Renaming a file.....	17
	9.2 Erasing	17
	9.2.1 Erasing a directory.....	17
	9.2.2 Erasing a file.....	18
	9.3 Entering a directory.....	18
	9.4 Return to root.....	18

9.5 Make a directory	18
9.6 Edit.....	18
10.1 Display language.....	21
10.2 Auto power.....	21
10.3 Screen save.....	21
10.4 Template selection	21
10.4.1 Template name	21
10.4.2 Recording file compression type setting "CORE"	21
10.4.3 Sampling Rate setting "SR".....	22
10.4.4 Bit Rate & Mono / Stereo selection "BR".....	22
10.4.5 File extension name setting "EXT"	22
10.5 Input device manager.....	22
10.5.1 Input device manager, NAME.....	22
10.5.2 Input device type manager.....	23
10.5.3 Input gain manager	23
10.5.4 Input boost manager.....	23
10.5.5 Input power manager.....	23
10.5.6 Input filter manager.....	23
10.6 Speaker mode	24
10.7 Set AGC target level.....	24
10.8 Set STOP key during record.....	24
10.9 Set OK key during record	24
10.10 Set display brightness	24
10.11 Lock input device gain.....	24
10.12 Set record name prefix.....	24
10.13 Date & Time.....	24
10.14 Clear record counter	24
10.15 Restore factory settings	25
10.16 Format disk	25
10.17 Check Disk space	25
10.18 Check Software version.....	25
10.19 Check Machine ID.....	25
11 EDITING	25
11.1 Editing display.....	26
11.1.1 Playback head position	26
11.1.2 Waveform.....	26
11.1.3 Marker A.....	26
11.1.4 Marker B.....	26
11.1.5 Play position.....	26
11.1.6 Run status.....	26
11.1.7 Modulometer.....	26
11.1.8 Marker A position.....	27
11.1.9 Marker B position.....	27
11.1.10 Original file length.....	27
11.1.11 Actual file length	27
11.1.12 Playback counter	27
11.2 Editing Menus	28
11.2.1 Jump position (GOTO function)	28
11.2.2 Markers	28
11.2.3 Undo table.....	28
11.2.4 Frames/Pixel (Graphic Zoom)	29
11.2.5 Playback around the edit.....	29
11.2.6 Trimming edit points.....	29
11.2.7 Completing the edit and saving the resulting file.....	29
11.2.8 Quick reference to the editor function keys:.....	29
12 ARES-M GAIN AND LEVEL STRUCTURE.....	30
13 LINE INPUTS ON THE ARES-M.....	31

14 MICROPHONES AND SETTINGS.....	31
15 LOW CUT FILTER OR NOT ON THE ARES-M.....	32
16 AUDIO COMPRESSION (WHY AND WHEN TO USE IT).....	32
17 MP2 OR MP3 IMPORT / PLAYBACK.....	33
18 USB	34
19 SOFTWARE UPDATE.....	35
20 FILE TYPES	36
21 ALARMS.....	39
21.1 Low battery	39
21.2 Low memory	39
22 DEFAULT SETTINGS	40
23 MESSAGES.....	41
24 LANGUAGE TABLE	42
25 SPECIFICATIONS.....	53
26 DECLARATION OF CONFORMITY.....	54
26 INDEX TABLE	55

1 GUARANTEE

Nagra / Kudelski certifies that this instrument was thoroughly inspected and tested prior to leaving our factory.

We guarantee the products of our own manufacture against any defect arising from faulty manufacture for a period of two years from the date of delivery.

This guarantee covers the repair of confirmed defects or, if necessary, the replacement of the faulty parts, excluding all other indemnities.

All freight costs, as well as customs duty and other possible charges, are at the customer's expense.

Our guarantee remains valid in the event of emergency repairs or modification being made by the user. However we reserve the right to invoice the customer for any damage caused by an unqualified person or a false manoeuvre by the operator.

We decline any responsibility for any and all damages resulting, directly or indirectly, from the use of our products.

Other products sold by KUDELSKI S.A. are covered by the guarantee clauses of their respective manufacturers.

We decline any responsibility for damages resulting from the use of these products.

We reserve the right to modify the product, and / or the specifications without notice.

Identification card.

Each ARES-M machine is delivered with its own unique identity card. The purpose of this card is to allow the user to keep information concerning his machine, and our full contact details available should the machine be lost or stolen.

We maintain an international database of lost or stolen NAGRA equipment, so if such a machine turns up for repair, or update it will immediately be identified.

Please keep this card safely, and please indicate the serial number and software version of your machine upon all correspondence concerning the recorder.



Unique serial #

NAGRA contact details

Please note: These cards are unique and cannot be replaced. Only ONE card per machine has been made.

2 DELIVERED WITH

The package includes:

- 1 Ares-M
- 2 Stereo mic (if ordered)
NM-MICS 2070 120 000
- 3 Windshield
NM-MWS 2070 124 000
- 4 End cap
NM-CAP 2070 131 000
- 5 Wrist-strap
NM-WSI 2070 114 000
- 6 Power supply & adapters
NM-PSU 2070 110 000
- 7 Mic cable
CM-MICM 2070 122 000
- 8 USB cable
CM-USB 2070 116 000
- 9 Headphone adapter
CM-HPA 2070 118 000
- 10 Line output cable
CM-LIN 2070 117 000
- 11 Carrying case
NM-CCI 2070 112 000
- 12 "AA" cells (2)
7098 301 000
- 13 CD including manuals
7070 103 000
- 14 Identity card



Note: Software updates and user manual reprints are available from www.nagraaudio.com (Pro, Support section)

3 PANEL DESCRIPTION

3.1 Front panel key functions

1 OK / II key:

- Pause / Next recording function during record.
- Pause function during playback.
- Executes functions in the menu mode.
- Selects PRE-RECORD from STOP.

2 REC led:

- Turns red during record (flashing).

3 Edit key:

- Removes the selected portion between 2 marks during editing.
- Removes the selected index in the directory.

4 A-B key:

- Selects the position of marker A or B in the edit mode.
- When hold, removes the markers A and B during edit.
- In all other modes, put the display into high brightness for 5 seconds.

5 Play / Stop / Power key:

- Main Power ON / OFF key. (Press for 3 seconds to power off)
- Toggles between play and stop.

6 C key:

- Cancels (escape) a menu operation or exits a display mode.
- Enters folder and setup menus.

7 Left key:

- Rewind key during playback.
- Decreases the input level sensitivity (Input gain) (0.5dB steps).
- Move to the "Left" in the menu mode or exit some menus.
- In the editing mode, (Stop mode) moves the marker backwards. In playback, the marker will be set to the play locator position.
- In the editing mode without markers during stop, moves the current position backwards.
- In the editing mode with markers, moves the selected marker backwards.

8 Down key:

- Decreases the input level sensitivity (Input Gain), (Coarse adjustment – locked by default).
- Skip forward to next index in the play mode.
- Moves to next available position in the menu mode.
- Fast forward in the editing mode.

9 Right key:

- Fast forward key during playback.
- Increases the input sensitivity (0.5 dB steps)
- Move "Right" in the menu mode.
- In the editing mode, (Stop mode) moves the marker forwards. In playback, the marker will be set to the play locator position.
- In the editing mode without markers during stop, moves the current position forwards.



- In the editing mode with markers, moves the selected marker forwards.
- In the menus, confirms a setting.

10 Up key:

- Increases the input level sensitivity (Input gain) (Coarse adjustment – locked by default).
- Skip back to previous index in play mode.
- Moves to the previous available position in the menu mode.
- Fast return in the editing mode. date
- Software update (together with the power on key)

11 Menu key:

- Display the sub-menu for fast input selections, templates etc. in the stop menu mode.
- Enter marker positions during record.
- In the edit mode, several additional functions: go to, marker list, undo erase, zoom level.

3.2 Left side key functions



1 Record switch:

- Sliding the switch up puts the ARES-M in record.

2 AGC switch (Automatic Gain Control):

- Sliding the switch up turns on the Automatic Gain Control
- In the edit mode it selects the playback mode (outside or inside markers) .

3 Hold switch:

- Sliding the switch up locks the keyboard controls.

3.3 Right side



1 USB port:

- Used for connecting to a PC / MAC for file download.
- External DC powering of the unit.

2 Output volume adjustments:

- Headphones, internal speaker & line output.
- In the sub-menus, permits to select a character or a number (name changing)

3 Line output:

- Stereo 3.5 mm line output jack.

4 Headphone output:

- Stereo 3.5 mm headphone output jack.

3.4 Top face

1 Cover:

- Removable protective cover hiding mike & line input connectors.

2 Line input:

- 3.5 mm stereo jack for line inputs.

3 Mike input:

- 3.5 mm stereo jack for external mike inputs.

4 Int Mic:

- Built-in Electret mono microphone.



3.5 Bottom face

1 Battery compartment:

- Slide down to open.



4 INSTALLING BATTERIES

Insert 2 "AA" batteries taking care of the correct polarity and close the cover. Rechargeable batteries (NiCd or Ni-mH) can also be used but they can not be charged inside the ARES-M.



5 FIRST POWER ON

Push and hold the **"Play & Stop"** key (5) for 3 seconds, the machine turns on and shows the ARES-M icon for 1.5 seconds followed by the **"STOP"** window display. To skip the ARES-M icon screen, press any key. To jump to the **"PRE-RECORD"** window, press the **"OK"** key.

6 RECORD WINDOW DESCRIPTION

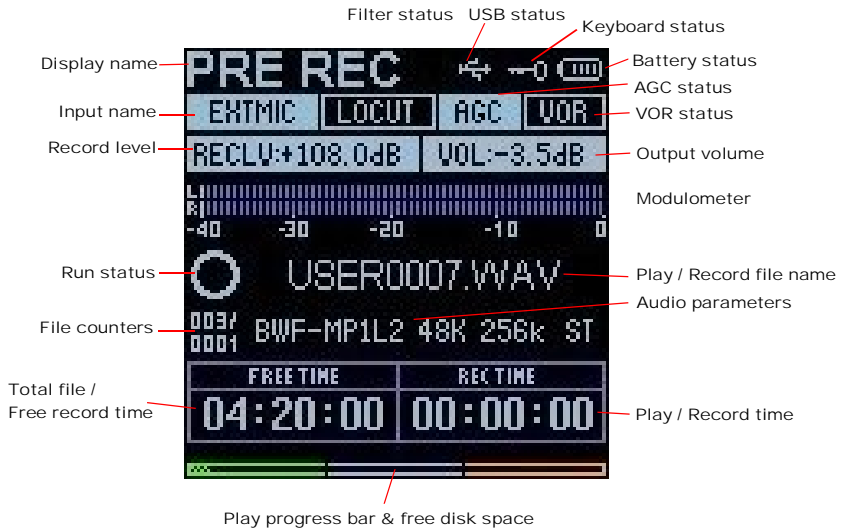

6.1 Display name

Area that indicates the name and function of the selected display

6.2 Input name

Indicates the input status (internal / external microphone or line input.)

6.3 Record level

The record level can be adjusted with the keys 7 & 9 in steps of 0.5 dB from +144 dB to +84 dB (60 dB range).

6.4 Filter status

Indicates if the low cut filter is ON or OFF. OFF is indicated by blue characters on a black background, ON is indicated by black characters on a blue background.

6.5 AGC status

Indicates if the Automatic Gain Control is turned ON or OFF (Left side button 2). OFF is indicated by blue characters on a black background, ON is indicated by black characters on a blue background.

6.6 Output volume

The output volume level for headphones, line output or internal speaker (play mode) can be adjusted with the buttons (Right side 2, VOL +, -) from - 40.0 dB to + 1.0 dB in 0.5 dB steps.

6.7 VOR status

Indicates if the Voice Operating Record is turned ON or OFF. OFF is indicated by blue characters on a black background, ON is indicated by black characters on a blue background.

6.8 Modulometer

Full scale from -40 dB to 0 dB with peak hold indicator for left and right channels.

6.9 Play / Record file name

The name of the current file during record or playback.

6.10 Play / Record time

Display in hours, minutes & seconds since the playback or recording was started.

6.11 Play progress & free disk space bar (3 colour)

During playback the entire bar corresponds to the selected file. The "filled-in" part indicates the playback progression. In stop or record mode, it indicates the remaining record space available in the memory.







6.12 Total file / Free record time

In playback the counter shows the duration of the current file and in record it shows the remaining capacity left in the memory.

6.13 File counters

The upper counter indicates the total number of recorded files. The lower counter indicates the number of the file ready to be played back.

6.14 Run status

-  Stop
-  Monitoring (EE) mode (pre-record buffer)
-  Record
-  Play
-  Forward
-  Rewind
-  Pause

6.15 Audio parameters

This area shows (left to right), the current file type, the sampling frequency, the bit rate and the Mono / Stereo selection.

6.16 USB status

This icon appears when the machine is connected via USB to a PC / MAC.

6.17 Keyboard status

The key icon appears when the keyboard is locked by means of the hold key (3) on the left side.

6.18 Battery status

5 stripes inside the icon indicate full capacity.

7 USING THE ARES-M

Basic Introduction and General Information.

The ARES-M is designed as a flexible hand-held recorder for a variety of applications. It can perform many functions, which are all covered in this manual. The operating concept is designed around a system of preset TEMPLATES in which all the required operating modes are stored. The user can choose different parameters of the machine and these personalised settings are stored in a template for future quick access. There are two sets of templates, one for the compression mode to be used and the other for different input devices.

If no specific user Template profiles are stored then the ARES-M will operate using the “default” factory settings.

This introduction covers various important global subjects. More complex operations can be understood by studying the different menus in detail. The topics covered are:

- Recording audio in the field
- Replaying a previous recording
- Storing settings in a template
- Editing a recording
- File / Folder management
- Downloading to a computer

7.1 Recording audio in the field

General preparation:

Before making a recording the input source and compression mode need to be chosen. The ARES-M makes recordings according to the pre-selected settings stored in the templates. If nothing is set prior to the first recording then the “default” settings will be adopted. If specific settings are required, then they must be selected first using a previously customized template.

- Input device (Internal / external microphone / Line input)
- Compression format (linear PCM, MPEG, a-Law, μ -Law, G729a)
- Working directory (Where the recorded files are to be stored)

Note: When selecting the input device, the input gain and the use (or not) of the input filter and power is automatically set according to the devices template.

Select the input device and compression mode (and working directory if necessary) using the “MENU” key according to the pre-saved templates.

When ready, press the “OK” key and the ARES-M will go to the “PRE-REC” mode where the audio input can be heard on the headphones and the levels seen on the display. In this mode the Pre-record buffer (max. 3 seconds) is also active.

If the AGC is turned off, the input gain can now be adjusted in 0.5 dB steps from +144 dB to +84 dB using the “LEFT” or “RIGHT” keys, and the value is shown in a sub-window on the display. Initially, the value corresponds to the preset value stored along in the input device template.

To begin recording, press the “RECORD” slide switch upwards (with default settings: Towards the microphone). The red LED will flash and the record symbol on the display will start flashing. The levels can be seen on the display and adjusted during recording as necessary, assuming the AGC is not activated.

To enter markers, during record, press the “MENU” key.

To stop recording, simply press and hold the “PLAY / STOP” key (5) for 3 seconds.

Note: If the recording is started directly from the **“STOP”** mode, the Pre-record buffer will be off. If during record the **“RECORD”** switch is pushed upwards again, a new file will be started (seamless recording).

Each new recording will be given a file name made up of 8 digits. This file will be stored in the working directory.
See “File naming and working directory” for details.

7.1.1 The Automatic Gain Control (A.G.C)

The AGC is not an audio limiter. It operates in the digital domain and allows the operator to make recordings without under / over modulating when the audio levels are unpredictable. It makes recording in the field easier and guarantees that a respectable level will be recorded. Automatic adjustment systems are rarely “better” than the manual modes, but can be considered “safer” in certain circumstances. The operating target level or average level to be recorded can be set to either -6 dB or -12 dB in the **“SCREWDRIVER”** menu. It is also strongly recommended to switch on the low cut filter when using the AGC for recordings in noisy environments (example: Street noise).

7.2 Voice Operated Recording

The VOR permits to start a recording depending on the input level. Two more parameters need to be entered (see also **“MENU”**). The first is to enter the recording duration after that the input signal falls 25 dB below the trigger level. The second is to select the VOR stop mode. The last parameter to enter is to set the trigger level to start a recording (VOR mode).

Once the VOR mode is turned on, the main display shows **“PAUSE”**. This means that the machine is ready to start the first record once the trigger level reached. If other menu parameters still need to be changed, press first the STOP key. Once the changes occurred, select again the VOR mode trigger level, or press the OK key (display returns to PAUSE).

Once a recording is started using the VOR mode it will be PAUSED automatically when one of the following applies:

- The input signal drops 25 dB below the threshold setting for more than X (User defined) seconds.
- The internal memory of the machine is full.
- The batteries of the machine are exhausted.

There are two modes of operation for the VOR system:

Split Track: Each VOR operation will create a new TAKE

Pause Rec: Each VOR operation will be added to the previous, thus creating a continuous TAKE.

Important: If after a power OFF / ON the display shows a PAUSE screen, it means that VOR is still turned on.

7.3 Playback of a previous recording

The ARES-M can play back files irrespective of the current compression mode selected. To playback the last recorded file, press **“PLAY”** and the machine starts playback immediately. To stop the playback, press the **“PLAY”** key again. To pause the playback, use the **“OK”** key.

If the recording was made with markers, during the playback, briefly press the **“RIGHT”** or **“LEFT”** keys to jump to the next or previous marker position respectively.

To playback another file from the same working directory, use the **“UP”** or **“DOWN”** keys to scroll through the recorded files available. Once **“PLAY”** is pressed, the new file will be played immediately.

During a playback of a file, the full 3 colour **"PLAY PROGRESS BAR"** corresponds to the total length of the file.

When a new file has been selected for playback the **"TOTAL TIME"** counter will indicate its full length and the **"PLAY TIME"** counter starts incrementing once the playback begins.

During playback, to **"REWIND"** press and hold the **"LEFT"** key, to go **"FORWARD"** press and hold the **"RIGHT"** key.

7.3.1 Adjusting playback levels

The output volume level for the headphones and line output can be adjusted by the **" + VOL -"** buttons on the right side of the machine in steps of 0.5 dB from -40 dB up to +1 dB. This value is also shown on the display (see Record window description) and stored in the memory of the machine.

7.4 Storing settings in a template

Templates are used to store the settings for the ARES-M. These templates contain input device, levels, filter selection, Electret powering, type of compression, mono or stereo etc.

Input device manager: 10 templates are available and each can store the name and characteristics of different input devices such as different microphone capsules, line inputs and the gain settings, powering and filters can be selected for each device.

Compression template: 10 templates are available and each can be given a dedicated name and can store the desired compression mode, sampling frequency, bit rate and the file extension desired.

To go to the programming position, jump to the paragraphs entitled **"MANAGER"** & **"SETUP MENU"**.

Once completed, the desired template can be selected by pressing the **"MENU"** key. Choose the corresponding template by its name in the **"Set compress template"** or **"Set input device"**.

7.5 Deleting an audio recording rapidly

Any audio file can be selected from the **"STOP"** mode by pressing the **"UP"** or **"DOWN"** keys. Once the corresponding file is shown on the display, press the **"EDIT"** key and confirm to delete the file.

8 MENUS

All the settings and parameters of the ARES-M are made through a selection of Menu's. There are two sets of menus. One is used for the selection of the pre-set choices and the other is used for storing the different settings of the machine.

Press the centre **"MENU"** key (11) and a sub-menu appears giving access to the input device selection, the compression template to be used, auto-record function, settings of the pre-rec buffer, the loop mode, search speed, input matrix and selection of the working directory.

The **"UP"** or **"DOWN"** keys (10) or (8) will highlight the different choices and the **"OK"** key (1) or **"RIGHT"** key (9) confirms the selection.

-  Set input device
- Set compress template
- Set VOR mode
- Set VOR stop mode
- Set VOR stop delay
- Set pre-rec buff
- Set loop mode
- Set search speed
- Set input matrix
- Set work directory

8.1 Menu Tree

The "Tree" shows all the different menus available. All **BLUE** text is preset in the "Setup" menus and can be personalized.

In general to set or confirm a selection, press the "OK" key (1) or the "RIGHT" key (9). To move to the right, use the "RIGHT" key (9). To move to the left or escape from the menu selection, press the "LEFT" key (7).

8.2 Set input device

Choice between the INTERNAL or EXTERNAL microphones or the LINE INPUT.

Pressing the "OK" key (1), allows selection between the line input, internal or external microphone. Press "C" twice to return to the main window. Each input name can be personalized in the "Setup" menu. To change the input device, highlight the new input and press "OK".

8.3 Set compress template

Allows the selection of different operating templates, containing all the recording compression settings.

Select the "Compress template" by using the "UP" (10) or "DOWN" (8) keys followed by pressing the "OK" key (19). The preset template can then be chosen from the list. Once selected, press the "OK" key (1).

Each template stores the following parameters:

- Template name
- MPEG 1 L II, MPEG 1 L III, G729a, a-Law, μ -Law or PCM selection
- Sampling frequency
- Bit rate & Mono / Stereo selection
- File extension name

This information is shown on the display in the audio parameters area.

8.4 Set VOR mode

Access to the parameters of the Voice Operated Recording mode trigger level. This sub-menu permits to set the minimum input level before the recording starts, or to turn off the VOR mode.

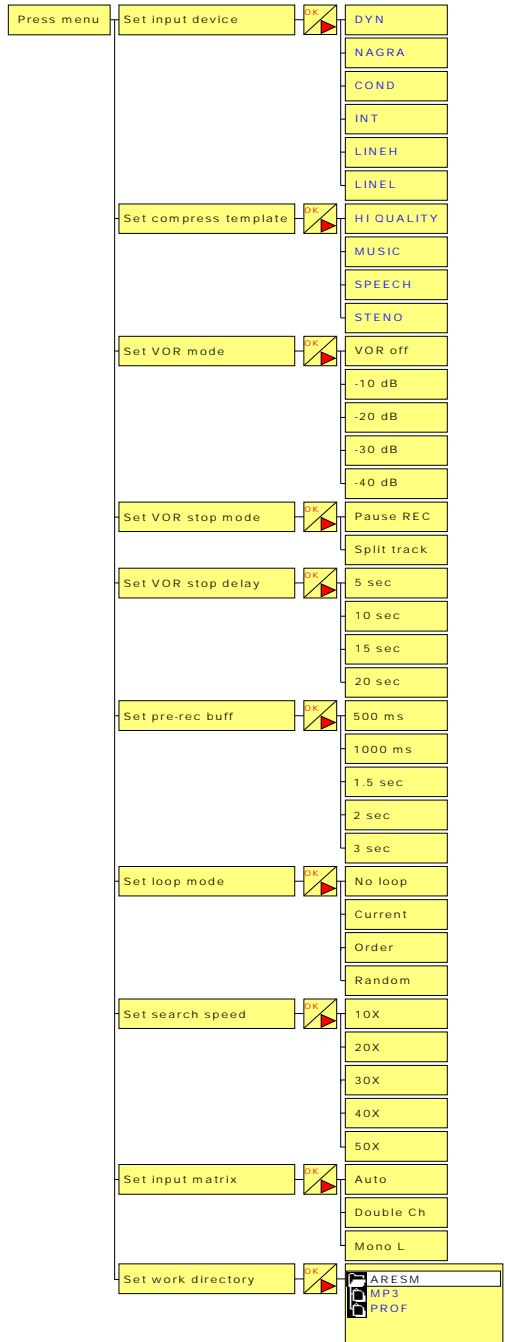

8.5. Set VOR stop mode

If "**Pause REC**" is selected, the recording will be paused (with default settings: depending from the stop delay) if the level drops 25 dB below the trigger level. If the input level rises again above the trigger level, the recording on the same file will continue.

If "**Split track**" is selected, the recording will be stopped (with default settings: depending upon the stop delay) if the level drops 25 dB below the trigger level. If the input level rises again above the trigger level, a new record will start.

8.6 Set VOR stop delay

Once the VOR recording started, it allows maximum recording length before it stops to be selected, if the input level drops to 25 dB below the trigger level.

8.7 Set the pre-rec buffer

Permits the size of the pre-record to be set.

8.8 Setting the loop mode

Permits the following possibilities in the playback mode:

No loop:	Plays the selected file once followed by stop.
Current:	Continuous playback of the selected file.
Order:	Playback continues with the next consecutive file.
Random:	Randomly selects the next file to be played.

8.9 Setting the search speed

Allows the search forward or backward speed when using the "**LEFT**" or "**RIGHT**" key to be selected. The speed can be set from 10x to 50x nominal speed.

8.10 Setting the input matrix

Permits to route the inputs to specific recording channels.

Auto:	If a stereo recording format is selected, the left input goes to the left recording channel, the right input goes to the right recording channel. If a mono recording format is selected, only the left input goes to the left recording channel.
Double Ch:	The left input is forced to the left recording channel, the right input is forced to the right channel and does not depend on the recording format (Mono or Stereo).
Mono L:	Only the left input is directed to both recording channels. In the case of a stereo recording with a single left input, both output channels will be identical.

8.11 Setting the work directory

Select the preferred sub-directory into which files are to be stored or played from and press "**OK**".

Note: Work directories can only be selected from this menu (Blue menu key). New work directories can only be created in the "**Setup**" menu. If the internal memory of the machine has just been formatted, only the "**ARESM**" directory exists.

9 FILE / FOLDER MANAGER

The “MANAGER” acts like the explorer on a PC. It offers the possibility to create, erase, move, copy and rename directories or files.

To access the “MANAGER” from the main display, press “C”, followed by the “LEFT” or “RIGHT” keys to select the “folder” icon and press “OK”.

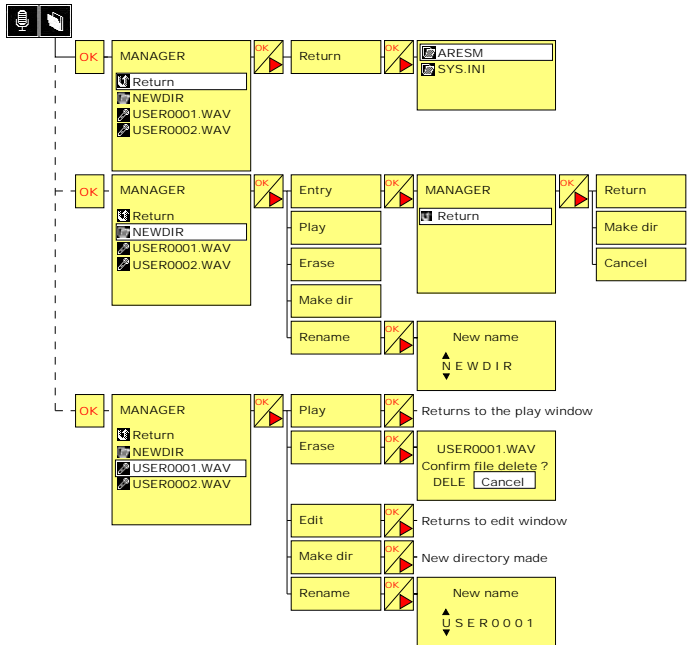

The following functions can be selected: Entry, Play, Erase, Edit, Make dir, Rename.

Note: Not all these functions will always appear. It depends on the selected file or folder (“SYSINI”, a “Directory” or an audio file “USERxxxx.wav”).

9.1 Renaming

9.1.1 Renaming a directory

To rename a directory, highlight the directory name and press “OK”. Then select “Rename” and press “OK”. The first character can now be changed by using the “+” or “-” volume keys or the “UP” and “DOWN” keys. Press the “RIGHT” key to move to the next character. Press “OK” when completed. A maximum of 8 characters can be entered.

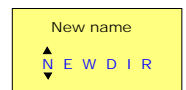

9.1.2 Renaming a file

To rename a file, proceed in the same manner as described for renaming a directory but by highlighting the file name to be changed.

9.2 Erasing

9.2.1 Erasing a directory

To erase a directory, highlight the directory name and press “OK”. Then select “Erase” followed by “OK”. A confirmation window appears to confirm the erasure of the directory and all included files. If “DELE” is selected the directory and all included files will be deleted.

9.2.2 Erasing a file

To erase a file, highlight the file name and press **"OK"**. Then select **"Erase"** and press **"OK"**. A confirmation window will appear. Select **"DELE"** and confirm by pressing **"OK"**.

9.3 Entering a directory

Highlight the directory name and press **"OK"**. Then select **"Entry"** and press **"OK"**. The files in this directory will then be shown.

9.4 Return to root



To return to the ROOT level, press **"OK"** then select **"Return"** followed by **"OK"** or press the **"LEFT"** key once to go back one level. Repeat this until at least the **"SYSINI"** folder is shown: This means that the ROOT is attended.

9.5 Make a directory

Press **"OK"** and select **"Make dir"**. Press **"OK"** once and the folder **"NEWDIR"** will be shown on the display.

9.6 Edit

Press **"OK"** and select **"Edit"**. The selected audio file will be shown in the edit display. Another possibility is to select first the audio file followed by pressing the **"Scissors icon"** key

Note: Editing is only possible on audio files recorded with the ARES-M if the file type is a-Law, μ -Law, G729a, PCM or MPEG 1 layer II. Audio files imported via USB cannot be edited. If in the "MANAGER" the selected audio file is shown with the icon  it can be edited, if it is shown with the icon  it cannot be edited. MPEG 1 layer II files recorded at 44.1kHz sampling frequency, even if generated on the ARES-M cannot be edited on the machine. MPEG 1 layer III files cannot be edited.

10 SETUP MENU

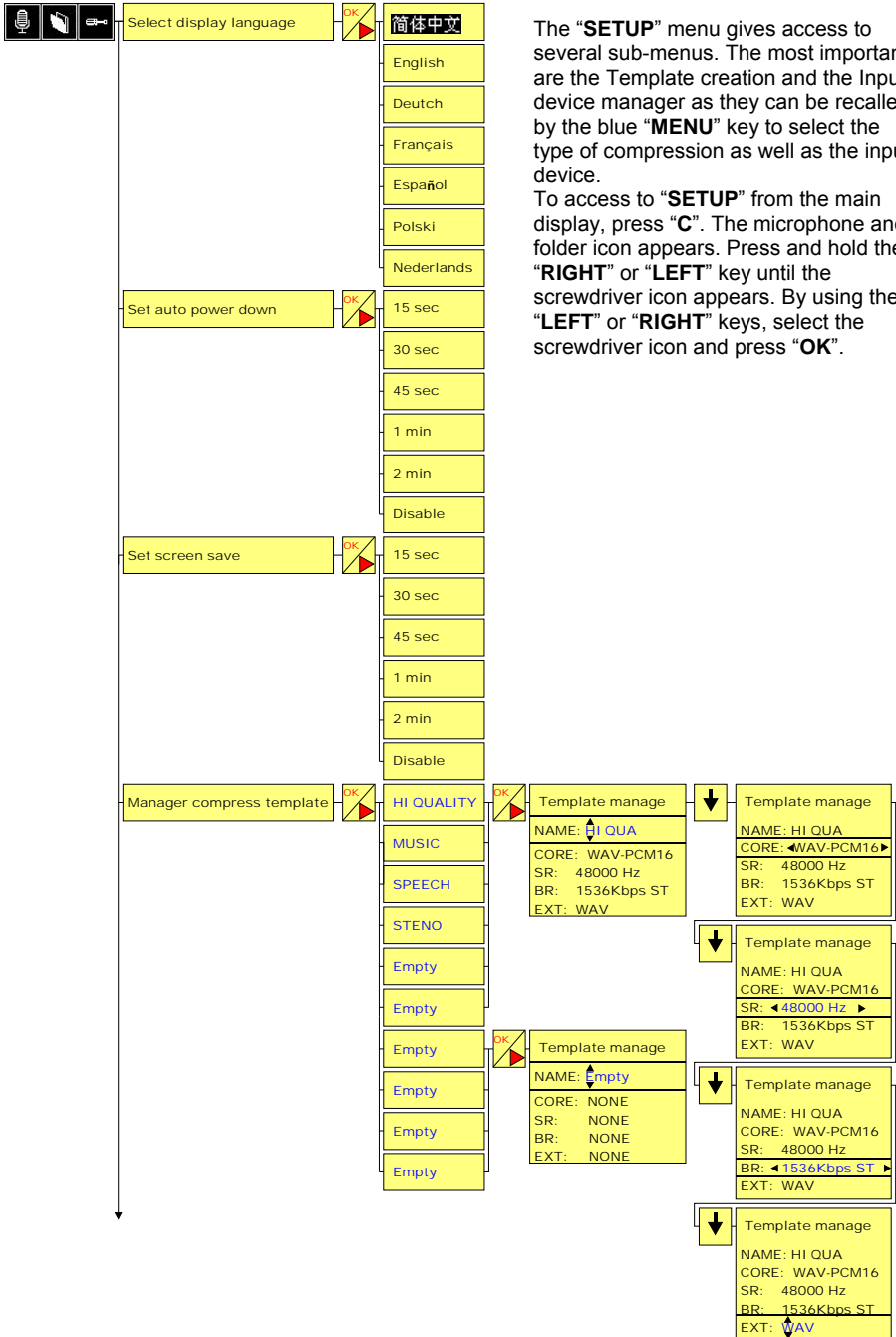

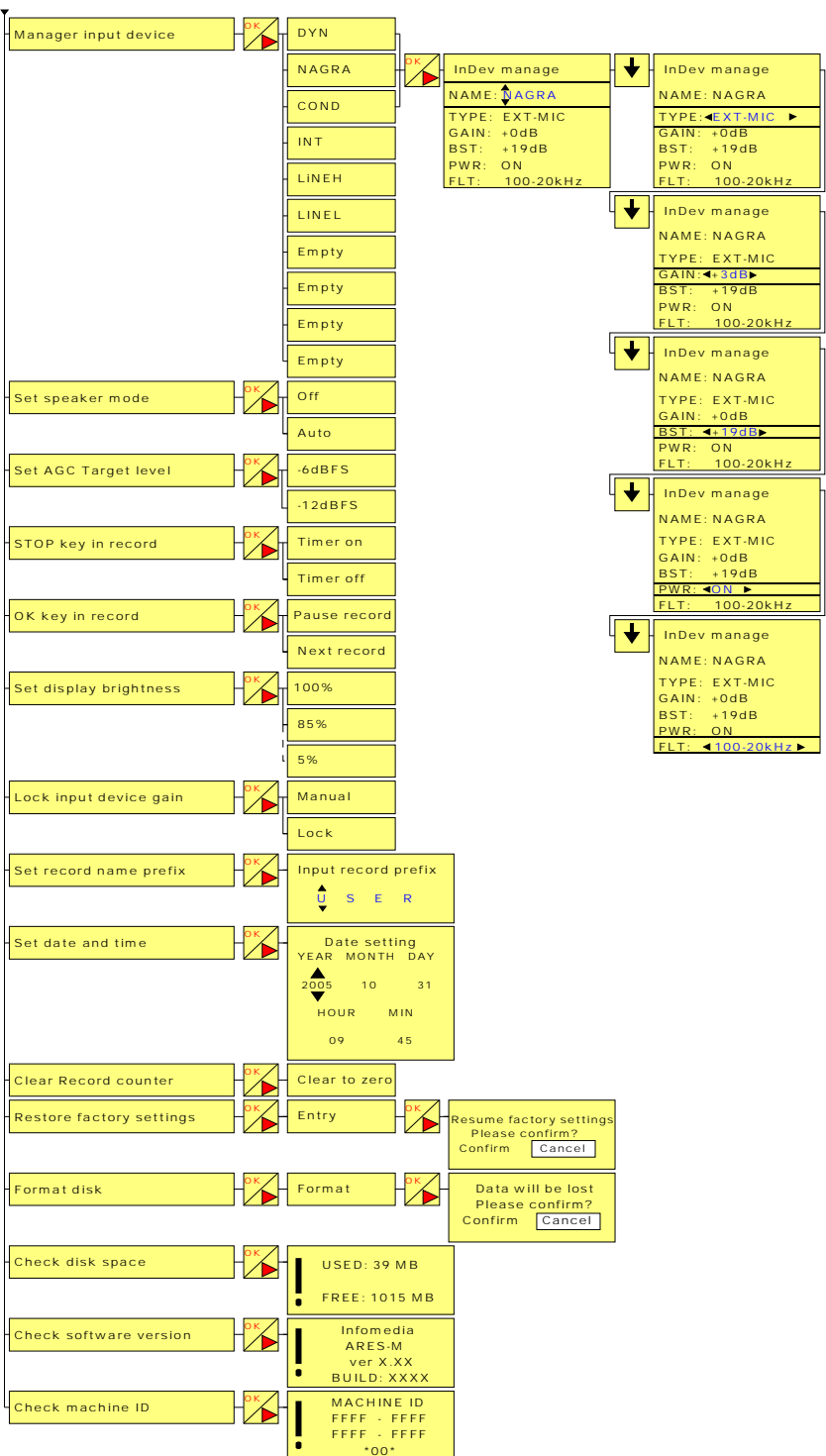

Note: While surfing through the different menu windows, in some cases not only the “OK” key or “RIGHT” key can be used to advance one step but also the “UP” and “DOWN” keys. To go one step back or to escape from a particular screen press “C” or the “LEFT” key.

When  appears, select the microphone icon and press “OK” to return to the main display.

10.1 Display language

Several languages are available: Chinese, English, French, German, Spanish, Polish, Dutch.

10.2 Auto power

This menu allows 5 possible settings to power down the machine when no keys were pressed for a period (except when in record, edit or play modes). It can be set to 15, 30, 45 seconds, 1 and 2 minutes. To turn the auto power down off, select “Disable”.

10.3 Screen save

To save battery power, the screen can be turned off automatically with 5 different settings. It can be set to 15, 30, 45 seconds, 1 and 2 minutes. To turn the screen save off, select “Disable”.

Note: If activated, the display will automatically turn off when no key is pressed for the selected period. Push any key to turn the display on again.

10.4 Template selection

Before the templates can be selected from the blue menu key, they first need to be stored. Maximum 10 templates for the input device as well as 10 templates for the compression can be entered. Templates are used to store different user profiles or “machine set-ups” for quick access.

10.4.1 Template name

Note: Remember that all text in blue colour (sample text) can be modified by the user.

To enter a new name or to change the name of a template, select the desired name “HI QUALITY” and press “OK”.

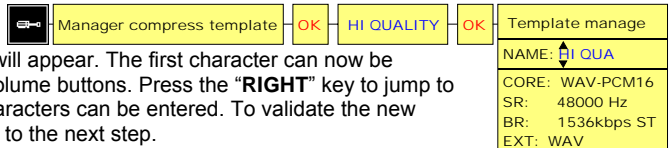

The window “Template manage” will appear. The first character can now be changed by using the “+” and “-” volume buttons. Press the “RIGHT” key to jump to the next character. Maximum 6 characters can be entered. To validate the new name press the “DOWN” key to go to the next step.

10.4.2 Recording file compression type setting “CORE”

Once the corresponding template is selected, press “OK” followed by the “DOWN” key to highlight “CORE”.

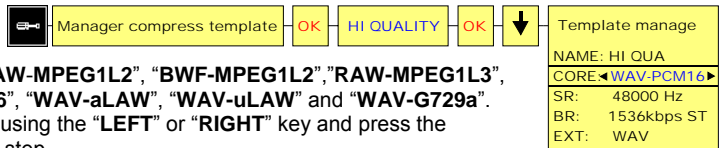

Several possibilities exist: “RAW-MPEG1L2”, “BWF-MPEG1L2”, “RAW-MPEG1L3”, “WAV-PCM16”, “BWF-PCM16”, “WAV-aLAW”, “WAV-uLAW” and “WAV-G729a”. Select one of the possibilities using the “LEFT” or “RIGHT” key and press the “DOWN” key to go to the next step.

10.4.3 Sampling Rate setting “SR”

Once the corresponding template is selected, press “OK” followed by “DOWN” twice to highlight “SR”.

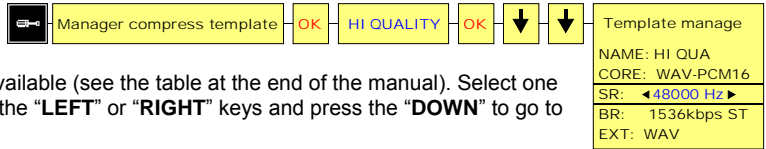

Several selections are available (see the table at the end of the manual). Select one of the possibilities using the “LEFT” or “RIGHT” keys and press the “DOWN” to go to the next step.

10.4.4 Bit Rate & Mono / Stereo selection “BR”

Once the corresponding template is selected, press “OK” followed by “DOWN” three times to highlight “BR”.

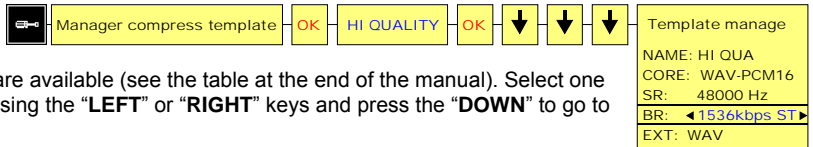

Several selections are available (see the table at the end of the manual). Select one of the possibilities using the “LEFT” or “RIGHT” keys and press the “DOWN” to go to the next step.

10.4.5 File extension name setting “EXT”

Once the corresponding template is selected, press “OK” followed by “DOWN” four times to highlight “EXT”.

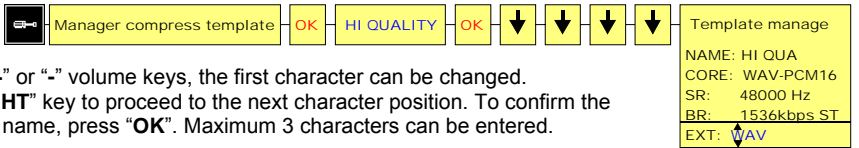

By using the “+” or “-” volume keys, the first character can be changed. Press the “RIGHT” key to proceed to the next character position. To confirm the new extension name, press “OK”. Maximum 3 characters can be entered.

10.5 Input device manager

This allows a specific name to be given to an input selection as well as the presets for the input gain, power and input filter selection for that particular device name.

10.5.1 Input device manager, NAME

To enter a new name or to change the name of an input device, first select the desired name “NAGRA” and press “OK”.

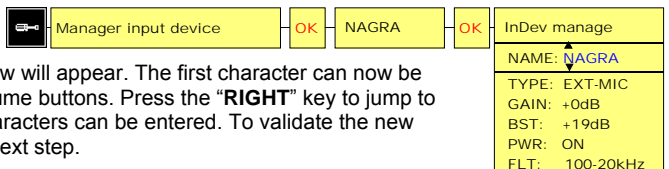

The “Input device manage” window will appear. The first character can now be changed by using the “+” or “-” volume buttons. Press the “RIGHT” key to jump to the next character. Maximum 6 characters can be entered. To validate the new name press “DOWN” to go to the next step.

10.5.2 Input device type manager

This sub-menu gives the selection of the input that will be used for recording. To change the input type, go to "Manager input device" and press "OK" followed by the "DOWN" key. Then "TYPE" will be highlighted.

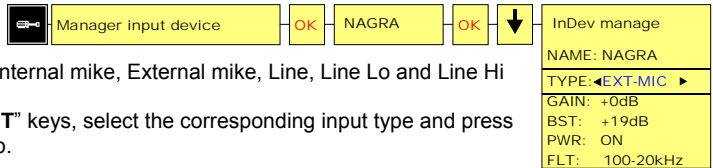

Five selections are possible: Internal mike, External mike, Line, Line Lo and Line Hi input.

By using the "LEFT" or "RIGHT" keys, select the corresponding input type and press "DOWN" to go to the next step.

10.5.3 Input gain manager

To change the input gain of an input device type, select the corresponding name and press "OK" followed by the "DOWN" key twice.

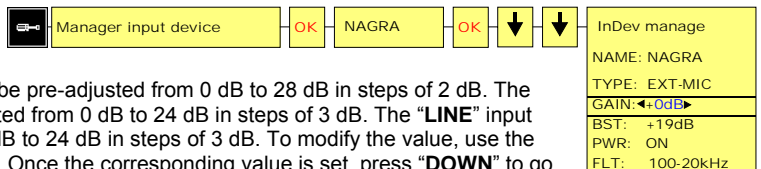

The "INT-MIC" gain can be pre-adjusted from 0 dB to 28 dB in steps of 2 dB. The "EXT-MIC" can be adjusted from 0 dB to 24 dB in steps of 3 dB. The "LINE" input can be adjusted from 0 dB to 24 dB in steps of 3 dB. To modify the value, use the "LEFT" or "RIGHT" keys. Once the corresponding value is set, press "DOWN" to go to the next step.

10.5.4 Input boost manager

Only for the "EXT-MIC" an additional boost can be added to the previous gain setting. To change the input boost, select the corresponding name and press "OK" followed by the "DOWN" key three times.

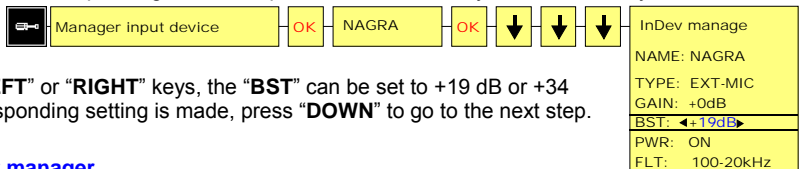

By pressing the "LEFT" or "RIGHT" keys, the "BST" can be set to +19 dB or +34 dB. Once the corresponding setting is made, press "DOWN" to go to the next step.

10.5.5 Input power manager

Power can only be turned on for the "EXT-MIC". To select the input power, select the corresponding name and press the "OK" followed by the "DOWN" key four times.

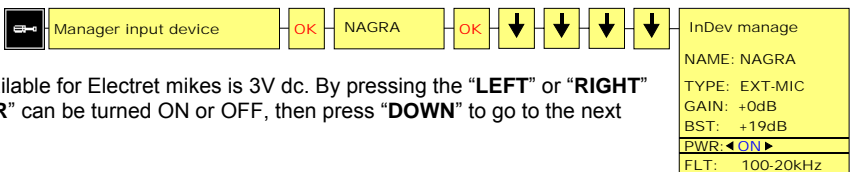

The power available for Electret mikes is 3V dc. By pressing the "LEFT" or "RIGHT" keys, the "PWR" can be turned ON or OFF, then press "DOWN" to go to the next step.

10.5.6 Input filter manager

A filter can be selected for the "EXT-MIC". To select the input filter, select the corresponding name and press "OK" followed by the "DOWN" key five times.

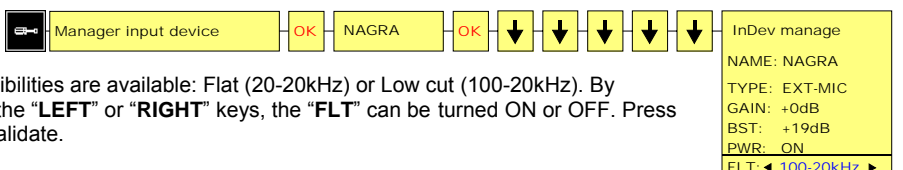

Two possibilities are available: Flat (20-20kHz) or Low cut (100-20kHz). By pressing the "LEFT" or "RIGHT" keys, the "FLT" can be turned ON or OFF. Press "OK" to validate.

10.6 Speaker mode

The ARES-M has a built-in speaker for audio monitoring. The speaker can be turned "Off" or set to "Auto". In the "Auto" mode the speaker is active during playback or editing only. During record or monitoring (EE) mode, the speaker is turned off.

10.7 Set AGC target level

This sub-menu allows the mean maximum target record level to be selected. 2 levels are available.

10.8 Set STOP key during record

Timer on selected: to stop a recording the stop key must be pressed and hold for approximately 3 seconds.

Timer off selected: if during a record the stop key is pressed, the recording stops immediately.

10.9 Set OK key during record

Pause record selected: if the OK key is pressed during record, the record is paused. To continue the record (same index), press the OK key once again.

Next record selected: Permits to use the OK key as a second record key. From stop mode, press once the OK key and the ARES-M is in PRE-REC mode, pressing a second time the OK key put the machine in record mode, pressing a next time starts a new seamless recording index.

10.10 Set display brightness

Permits to adjust the display brightness from minimum 5% up to 100%. If set to 100%, the brightness key (4) on the front panel is disabled. Beware that the current consumption for high brightness will decrease the battery life. The default settings is 25%.

Consumption at 25% is 100 mA, at 100% is 115 mA, at 5% is 85 mA.

10.11 Lock input device gain

Permits to lock or unlock (Manual) the input gain ("UP" & "DOWN" keys) adjustment from the record or pre-record display. Normally the input gain is stored in the input templates.

10.12 Set record name prefix

This sub-menu allows 4 characters to be entered. Once being in the "Input record prefix" menu use the "+" or "-" volume keys to select the corresponding character. Press the "RIGHT" key for the next character position. Once all characters entered, press "OK".

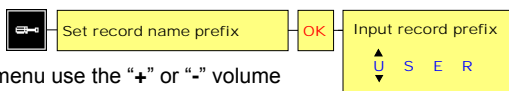

Example of a file name: USER0001.

10.13 Date & Time

The "DATE & TIME" sub-menu permits to set the correct time start and date for each recording. Use the "UP" or "DOWN" keys to set "YEAR". Use the "RIGHT" or "LEFT" keys to go to the next step. Once the settings made, press "OK".

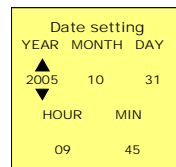

10.14 Clear record counter

Every recording has an index number incrementing automatically. Resetting the counter, by pressing "OK" when "Clear to zero" is shown, resets it to 1. The next recording will have the full name XXXX0001.

Note: If there are still files in memory and the USER name has not been changed, the next recording with the same name prefix and index will overwrite the old one.

10.15 Restore factory settings

This sub-menu is used to restore the factory “default” settings, including the template settings, names, input devices etc. After restore, the machine is set for a Nagra mike input with the low cut filter on, recording in PCM standard WAV, 48 kHz stereo.

10.16 Format disk

If all information on the internal memory needs to be erased, the fastest way is to format it. Once formatted, the three xxx.dat files in the “**SYSDIR**” folder will be re-entered in the root, just before power off. “**No File**” will be shown on the display.

Note: The xxx.dat files are storing all the entered templates, language selection, record name prefix etc.

10.17 Check Disk space

Indicates in Mbytes, the remaining space left in the memory.



10.18 Check Software version

This sub-menu shows the type of the machine and the software version installed.

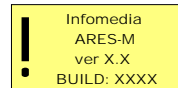

10.19 Check Machine ID

Shows the unique identification number of the machine.

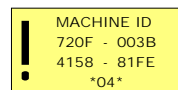

11 EDITING

The ARES-M is fitted with an internal audio editor allowing basic “cut” editing by the user in the field. It allows “high lighted” sections of audio to be either removed or to be saved as a new file. This is done by the setting 2 markers, A and B and then deleting or saving the portion between the 2 points.

In addition several “position markers” can be placed anywhere throughout the audio piece which serve as different cue points for the quick location of different specific points in the audio. These markers are totally independent from the two “cut” markers “**A**” and “**B**”.

To begin editing on a file, go to the “**MANAGER**” (folder icon) by pressing “**C**” and then choose the file to be edited. Press the “**EDIT**” key (3) (alternatively press the “**OK**” key followed by selecting “**Edit**” and “**OK**”). The selected file will then appear as a graphic display representing the audio.

IMPORTANT NOTE: Only files recorded on the ARES-M can be edited except if they are recorded in MP3 (any sampling rate) or in MP2 at 44.1 kHz

11.1 Editing display

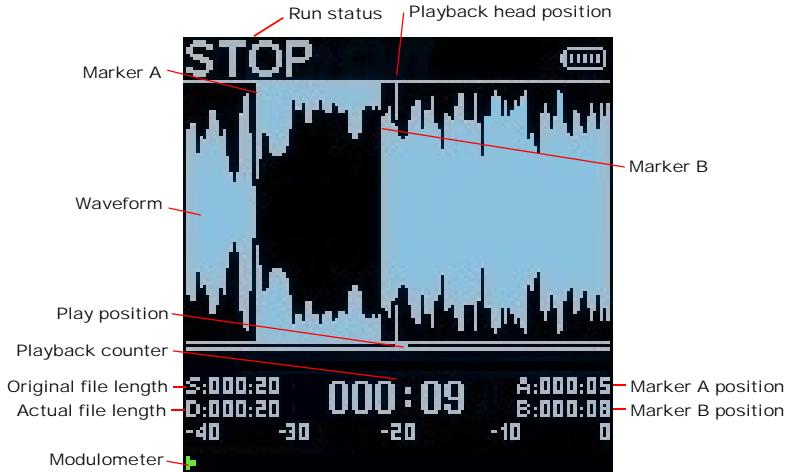

Description of the different display indications

11.1.1 Playback head position

This is the exact position, during playback, on the waveform.

11.1.2 Waveform

The full length of the screen corresponds to approximately 10 seconds of sound (without zooming).

11.1.3 Marker A

To set the first "CUT" marker, press the "A-B" key once (during playback or stop mode).

11.1.4 Marker B

To set the second "CUT" marker, press the "A-B" key again (during playback or stop mode). Once the second marker is set, the portion of the waveform between marker A and B will be shown as inverted (As shown above).

To jump alternately from the marker "B" position to the marker "A" position, press the "A-B" key (4). To remove the markers "A" & "B", press and hold a few seconds the "A-B" key.

11.1.5 Play position

The small moving indicator shows the playback position versus the total length of the file.

11.1.6 Run status

Indicates if the mode of the machine (stop, play).

11.1.7 Modulometer

Full scale from -40 dB to 0 dB with peak hold indicator for left and right channels.

11.1.8 Marker A position

Indicates the exact position of marker A with respect to the beginning of the file.

11.1.9 Marker B position

Indicates the exact position of marker B with respect to the beginning of the file.

11.1.10 Original file length

Indicates the original total length of the file.

11.1.11 Actual file length

Indicates the actual length of the file. If no cuts were made, it corresponds to the original length.

11.1.12 Playback counter

Indicates the exact playback position with respect to the playback "head" position.

11.2 Editing Menus

While in the editing mode, pressing the MENU key can access four different editing menus, which are very helpful to the user.

11.2.1 Jump position (GOTO function)

To rapidly "GOTO" a known point in the audio file simply put the location (in minutes and seconds) in the "Jump position" and press "OK". To do so, press the "Menu" key. A sub-window appears allowing the requested position to be entered in minutes and seconds. Use the "UP", "DOWN" keys to select the correct number, use the "RIGHT" and "LEFT" keys to move the cursor horizontally. Once all numbers entered, press "OK" and the playback point will jump immediately to that location.

This feature is especially useful when editing long files: jumping to the very beginning or end of the file can be done easily by holding the "LEFT" or "RIGHT" key down so the jump position goes to 000:00 or 999:99 respectively.

11.2.2 Markers

Two types of markers can be used during editing:

- Cut markers "A" and "B" (maximum 2). These markers are used to cut or save the marked area.

To set the first cut marker during play or stop, press the "A-B" key once, and a second time to set the second cut marker. They can be removed by holding the "A-B" key until they disappear (This will not remove the selected audio portion). Once the cut markers are in the right place, press the "CUT" key (3) and the marked area (Inverted colour) will be removed. If the marked area needs to be saved as a new file, press the "OK" key. A confirmation window will appear. If confirmed, the portion between the markers will be saved as "USER000X-1.XXX".

- Location markers. Several markers, for rapid location of points in the audio can be entered during playback in the edit mode.

By pressing the "OK" key during playback in the edit mode consecutive location markers will be stored. Press the "MENU" key twice to see the list of location markers that have been set. Move the cursor to the desired marker and press "OK" and the editor will immediately jump to this location. These markers cannot be removed or altered once set.

11.2.3 Undo table

Pressing the "MENU" key three times will show the Undo table. If by error, an incorrect portion was cut while editing, it can be restored via Undo table. Select one of the Undo rows and press the "OK" key and the portion will be re-integrated into the graphic and will be shown inverted (Cut markers are present).

Example: "1 06-06-14 11:41" means that cut # "1" made on July 14, 2006 "06-06-14" at 11h41 will be restored to the original if "OK" is pressed.

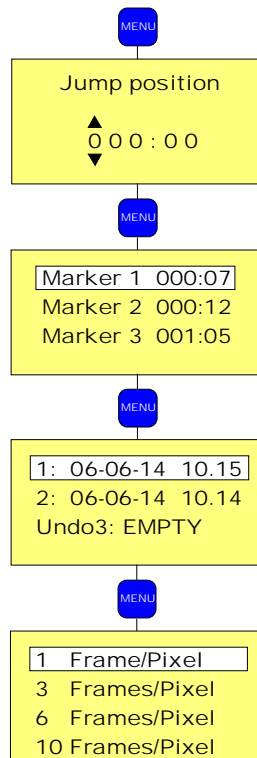

11.2.4 Frames/Pixel (Graphic Zoom)

Horizontal zoom-in can be obtained step-by-step by pressing the “**MENU**” key 4 times, select between 1 to 10 frames per pixel using the “**UP**” and “**DOWN**” keys to choose the desired Zoom and press the “**OK**” key. (“1” represents greatest zoom while “10” represents the least zoom).

11.2.5 Playback around the edit

Once the two “**CUT**” points “**A**” and “**B**” have been set, there are two ways of listening to the audio. The first is to listen from 3 seconds before the first cut marker, then “**SKIP**” or “jump over” the portion between the A and B markers and then continue to play for 3 seconds after the second cut marker. This is a loop feature and will continue until **STOP** is pressed. This mode is selected by leaving the AGC switch OFF (towards the bottom of the ARES-M).

The second method is to simply play the section between the markers without any “pre-roll” or “post-roll”, by putting the AGC switch to the ON position.

These two methods allow the edit to be listened to accurately before the actual cut is made or the audio portion is saved.

11.2.6 Trimming edit points

If one of the cut markers is not in the correct place, it may be trimmed.

Select the desired “**CUT**” marker by briefly pressing the “**A-B**” key. Press the “**LEFT**” or “**RIGHT**” keys to slide the marker frame-by-frame to the left or right. If the “**LEFT**” or “**RIGHT**” keys are held, the marker will move at approximately 10 frames per second. If the “**UP**” or “**DOWN**” keys are pressed briefly, the corresponding marker will move at a rate of 100 frames/sec. If the “**UP**” or “**DOWN**” keys are held, the corresponding marker will move at a rate of 1000 frames/sec.

11.2.7 Completing the edit and saving the resulting file

Once the file is cleaned it can be saved by pressing the “**C**” key (6). A sub-window appears giving the possibility to return to the edit window “**Cancel**” or to abort the editing “**Don’t**” or to “**Save**” the editing. The file will be saved as a new file.

Example: File USER0004 was used for edit, the edited file will be called USER0004-1

If an audio portion needs to be saved (AGC switch is ON and marker A & B is set), press the “**OK**” key and it will be saved as a new file.

Example: File USER0004 was used to select an audio portion, the new file will be called USER0004-2 etc.

11.2.8 Quick reference to the editor function keys:

OK	Place location marker / Save selection as...
UP	Fast return / Move marker to the left
DOWN	Fast forward / Move marker to the right
PLAY / STOP	Start or Stop the audio playback
AB	Set cut markers / Jump between cut markers / remove both cut markers
CUT	Remove highlighted section of audio
RIGHT	Slow forward / Move marker step-by-step to the right
LEFT	Slow return / Move marker step-by-step to the left
C	End editing (save as or undo or cancel)
AGC	Listen with / without Pre and Post roll

12 ARES-M GAIN AND LEVEL STRUCTURE.

The input of the ARES-M has 3 principal stages: The analogue microphone pre-amplifier “front end”, the PGA (Programmable Gain Amplifier) and the DGA (Digital Gain Adjustment). Different adjustments are available at all three stages. Only one, the “recording level” is readily accessible from the front panel by the user (using the left/right keys).

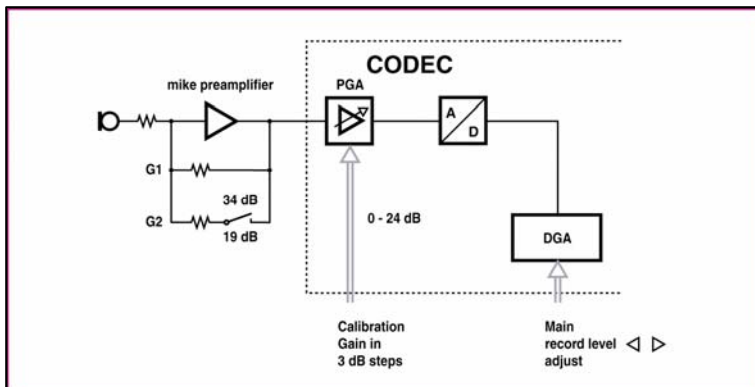

The microphone pre-amplifier stage has two selectable sensitivity settings which correspond to a typical dynamic microphone (34 dB) and the NAGRA microphone (19 dB); this selection is made in the “Screwdriver” menu in the “Input device manager”.

Dynamic microphone sensitivity is low and needs more gain than a condenser or Electret microphone. So, if a dynamic microphone is used, 34 dB gain is needed, and if a condenser microphone such as the NAGRA one, or any other external condenser microphone (such as the SONY ECM MS907 Stereo microphone) then 19dB gain should be selected. The correct selection of this gain will avoid the saturation of the PGA and DGA stages.

In the Codec section of the machine the first stage is equipped with a PGA adjustable gain setting allowing the modulometer to be calibrated to give an accurate indication of SPL (Sound Pressure Level). This setting is available in 3 dB steps and is also found in the Screwdriver menu and allows a range of 24 dB variation. This value is factory set to 9 dB for the NAGRA microphone and 6 dB for an external dynamic microphone such as a Sennheiser MD21.

Finally, the MAIN RECORD LEVEL is the actual level that should be used to adjust the recording level during operation of the machine and is accessible using the Left and Right keys without any need for going into the menus. This task is achieved by the DGA, and the range of adjustment allows 0dB Full Scale to be displayed on the modulometer for 84 dB to 144 dB SPL. The normal range of acceptable input levels ranges from 84 dB to 110dB SPL. The range from 110dB to 144 dB SPL will not allow 0 dB to be indicated on the modulometer without risk of saturation of the codec.

84 dB is the usual setting for an interview in a quiet environment. 110 dB allows the recording of somebody shouting at a distance of about 40 cm from the microphone.

The zone from 110 to 144 allows the user to make a fade out or to record with headroom (by recording below the 0dB point on the modulometer).

13 LINE INPUTS ON THE ARES-M

The line inputs of the ARES-M are asymmetrical and present an input impedance of about 60 kΩ. They allow the entire dynamic range of the machine to be used, typically 95 dB ASA weighted when measured on the USB output, or 92 dB ASA weighted on the analogue outputs.

Two sensitivities are available: Line H (for High level inputs) and Line L (for low level inputs). The Line H position allows 0 dB to be recorded throughout the input voltage range of 300 mV to 4.9V and the Line L from 19 mV to 310 mV.

The adjustment zone (using the level adjustment keys) ranges from +20 dB to -12 dB in the Line H mode and -3 dB to -35 dB in Line L (referenced to 1V).

As an example, one can say that if the modulometer indicates -10dBfs and that the level adjustment is set to -12 dB, then the input level is 12db - 10 dB= -22 dB with respect to 1 V or in other words 794 mV.

The following drawing clarifies the above.

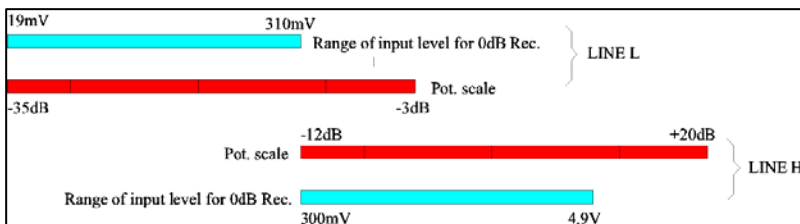

14 MICROPHONES AND SETTINGS.

The ARES-M can use the following microphones:

- Internal built-in mono microphone
- External standard stereo clip-on mic (Red band)
- External mono clip-on mic (Blue band)
- External high quality stereo clip-on mic (Green band)
- External dynamic microphone (with cable)
- External electret microphone (with cable)



For each of these microphone types an “Input device” should be pre-programmed allowing quick selection in the field. In the input device manager (Screwdriver set-up menu) various different parameters can be set and these vary for the different types of microphone. Below is a table showing our “recommended” settings for various mics. You may choose to alter these settings to get different performance but the indicated settings are optimal suggestions.

Microphone	Type	Gain (dB)	BST (dB)	PWR	FLT
Clip-on (Red)	Ext-Mic	+9	+19	ON	100-20 kHz
Clip-on (Blue)	Ext-Mic	+9	+19	ON	100-20 kHz
Clip-on (Green)	Ext-Mic	+9	+19	ON	100-20 kHz
Generic Dynamic	Ext-Mic	+6	+34	OFF	20-20 kHz
MD-21 (Sennheiser)	Ext-Mic	+6	+34	OFF	20-20 kHz
RE-6 (Electrovoice)	Ext-Mic	+12	+34	OFF	20-20 kHz
ECM-MS907(Sony)	Ext-Mic	0	+34	OFF	20-20 kHz

This built-in internal microphone should be considered only for “Dictaphone” quality speech recordings. It should only be used in emergency situations where no other microphone is available.

The standard Stereo microphone (Red band) contains two cardioïd capsules, and is the standard microphone delivered with the ARES-M.

The high quality stereo microphone (Green band) has two cardioïd capsules inside, mounted on special shock resistant neoprene mountings. The capsules are individually selected and matched in both noise and gain characteristics, according to a strict selection and measurement protocol. This microphone offers a good stereo image, and is very versatile.

The mono capsule (Blue band) is an omni-directional capsule, which offers two principal differences to the stereo capsule. Firstly, being an omni capsule it captures much more of the ambience and is ideal for on-the-move journalism, especially because most interviews are mono. Secondly, in an interview situation it is not necessary to “point” the microphone at the person speaking. The omni-direction characteristics allow all those being recorded to be captured equally, hence making the journalist job less intimidating. In addition it offers longer recording times to the ARES-M as the recorded files are mono.

The use of the foam windshield is strongly recommended with the clip-on NAGRA microphones.

15 LOW CUT FILTER OR NOT ON THE ARES-M

The ARES-M is equipped with a analogue low cut filter integrated within the microphone pre-amplifier. This filter can be turned ON of OFF as desired.

Frequency response curve of the External microphone pre-amplifier (flat and Low cut) :

The frequency of the cut is at 200Hz with a gradient of 40 dB / octave. This filter can be activated for each microphone type, as defined in the USER list (DYN, NAGRA, COND.....) It is specially useful for recordings made using directional microphones outside in windy conditions, such as the stereo NAGRA microphone. In fact, cardioïd (speed capsules) such as the NAGRA microphone are susceptible to vortexes induced by wind moving round the microphone capsule, contrary to omni-directional (pressure) capsules, which are not.

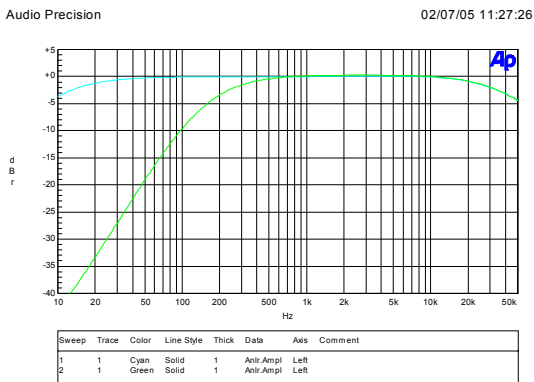

Note however that the NAGRA microphone is equipped with a fine silk screen directly behind the grill / basket carefully positioned to compensate for these vortexes and “pop” effects. It is also recommended to use the external foam windshield whenever one works outside when unexpected wind noise may be encountered.

16 AUDIO COMPRESSION (WHY AND WHEN TO USE IT).

The ARES-M is able to record using different Audio qualities PCM Linear, A-Law, μ -Law, MPEG 1 Layer II (MP2) and MPEG layer III (MP3) that have their own particular advantages, which are explained below.

What to use?

Firstly, the less compression used, the better the quality will be. However at higher bit rates (384 kbits/s) you can easily record music and it will probably not notice any difference.

A few guidelines should be considered:

For journalism / interview work it is unnecessary to use PCM linear. Generally MPEG 1 Layer II is used and the compression / bit rate is generally defined by the broadcaster.

For music / effects PCM linear is the best quality although MPEG at a high bit rate is probably good enough and gives faster download time.

For ultra long recordings use a very low bit rate, where quality will be "Dictaphone" quality.

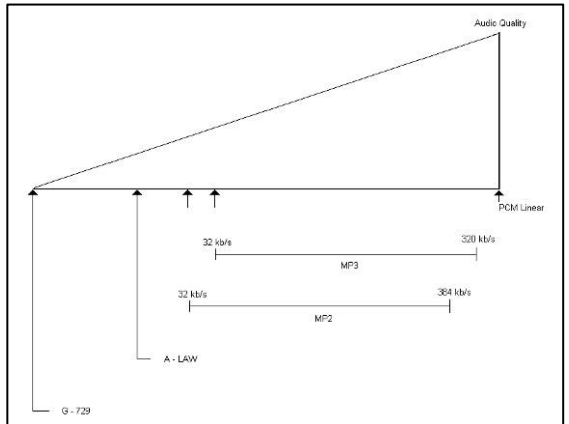

Some important things to remember:

- Some computers will not play MPEG 1 Layer II compressed files without an appropriate audio editing software. Typically some versions of the Windows Media player fall into this category.
- Audio CD's will only accept 44.1 kHz linear PCM if they are to be played on a standard CD player.
- Download speed from the machine to the computer is at a fixed bit rate and the full memory (in whatever format) will take about 20 minutes to empty. This could correspond to 1h26m of PCM linear or equally 34h of MPEG (as an example). Looking at it from the other direction, 1 hour of recording in PCM will take 12½ minutes and the same duration in MPEG 1layer II at 128 kbits/s would download in 1m 10s.

17 MP2 OR MP3 IMPORT / PLAYBACK

MP2 or MP3 audio files can be imported via USB. To playback, select the corresponding file and press play.

Note: The name of each file to be imported must not be modified except if the same filename exist already. Beware that those imported files cannot be edited on the Ares-M.

18 USB

The miniature USB port serves two purposes: File download or external DC powering. As the internal memory of the ARES-M cannot be removed, audio can be extracted either through the line output in normal playback mode or alternatively via the USB port to the PC / MAC.

Connect the USB cable to the computer and to the ARES-M. The ARES-M will immediately switch on as it is automatically powered through the USB connection.

When the USB is connected, a sub-window appears giving the possibility to select “**USB POWER**” or “**USB TRANSFER**”. Make a selection and press the “**OK**” key.

The USB power position is for simply powering the ARES-M through the USB port for normal operation without internal batteries.

If the USB transfer is selected, the machine will immediately appear as a removable disk in the explorer of the PC/MAC. And the following display will be shown on the ARES-M:



On a PC, the Windows Explorer will display the following:

Name	Size	Type	Date Modified
SYSDIR		File Folder	17.10.2005 02:10
USER0001.DIR		File Folder	17.10.2005 03:05
USER0002.DIR		File Folder	17.10.2005 03:24
USER0003.DIR		File Folder	17.10.2005 03:59
USER0001.WAV	1'243 KB	Wave Sound	17.10.2005 03:05
USER0002.WAV	1'059 KB	Wave Sound	17.10.2005 03:24
USER0003.WAV	861 KB	Wave Sound	17.10.2005 03:59

PC

As an example of 3 recordings, it shows 4 folders and 3 audio files:

- SYSDIR - Is the folder that contains the files with all the stored settings.
- USER000X.DIR - Are the folders containing the audio envelopes and editing information.
- USER000X.WAV - Audio files

Note: Do not erase the “**SYSDIR**” folder because the next time the machine will be turned on it “wakes up” with the default factory settings. If several ARES-M machines need to be set up with the same parameters, this folder can be copied from the first machine and then copied into all the other machines.

An identical situation of 3 recordings is shown on the next picture.



MAC

Beware that xxx.wav files are recognized by Mac as PCM files. MPEG files need to be recorded with the extension xxx.mp2 or xxx.mp3.

19 SOFTWARE UPDATE

Important: As a safety precaution, before updating the Ares-M, be sure that all audio files are saved on your Mac or PC, this is to prevent any loss of audio files.

To install new software in the Ares-M, a computer, the machine and a USB cable are needed. New software, called "APP.COE" can be downloaded from the web at www.nagraaudio.com

Important: Be sure that you have downloaded the APP.COE software corresponding to your ARES-M and not the one for ARES-M II or others.

Before updating, verify that the batteries inside the machine are in good condition.
Before connecting the machine via the USB cable to the PC or MAC, the machine must first be switched on using a key combination: Press and hold the "UP" key (10) while pressing the power-on key (5).

The display will show the following text:

System update

1. Check battery power
2. Plug in USB cable
3. Copy "APP.COE"
4. Remove USB cable
5. Wait for shutdown
6. Turn on the device

1. Must be checked before "System update"
2. Connect the USB cable between the machine and the PC, run explorer and search for the removable disk called "UPDATE":



3. Copy the new "APP.COE" to the Ares-M
4. Before disconnecting the cable, dismount the USB mass storage device from the desktop.
5. The ARES-M will automatically shut down.
6. Switch on the ARES-M and verify the software version.

Note for Windows 2000 & XP users: If the Explorer window doesn't show the file "APP.COE", check the following:

In Explorer, select "Tools", followed by "Folder Options".

In the "Folder Options" window, select "View".

In the "View" section, verify that "Show hidden files and folders" is checked.

In the "View" section, verify that "Hide protected operating system files (Recommended)" is not checked.

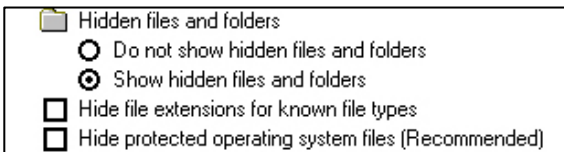

Note for Mac X.4 (or higher) users: If the file APP.COE appears locked (padlock icon as shown on the above MAC picture) the file must be unlocked before it can be replaced by the new software. Use the Mac program "Buddy 8" or a program "File Buddy 9" or similar to unlock.

20 FILE TYPES

Recording	Sampling	Bitrate	Mono	Rec. T	Recording	Sampling	Bitrate	Mono	Rec. T
type	Frequency		Stereo	On 1 GB	type	frequency		Stereo	On 1 GB
	Hz	kb/s	M / S	h m		Hz	kb/s	M / S	h m
WAV-PCM16	48000	768	M	2h53	BWF-MP1L2	32000	56	M	39h40
WAV-PCM16	48000	1536	S	1h26	BWF-MP1L2	32000	64	M	34h43
WAV-PCM16	44100	705	M	3h08	BWF-MP1L2	32000	64	S	34h43
WAV-PCM16	44100	1411	S	1h34	BWF-MP1L2	32000	80	M	27h46
WAV-PCM16	32000	512	M	4h20	BWF-MP1L2	32000	96	M	23h08
WAV-PCM16	32000	1024	S	2h10	BWF-MP1L2	32000	96	S	23h08
WAV-PCM16	24000	384	M	5h47	BWF-MP1L2	32000	112	M	19h50
WAV-PCM16	24000	768	S	2h53	BWF-MP1L2	32000	112	S	19h50
WAV-PCM16	22050	352	M	6h17	BWF-MP1L2	32000	128	M	17h21
WAV-PCM16	22050	705	S	3h08	BWF-MP1L2	32000	128	S	17h21
WAV-PCM16	16000	256	M	8h40	BWF-MP1L2	32000	160	M	13h53
WAV-PCM16	16000	512	S	4h20	BWF-MP1L2	32000	160	S	13h53
WAV-G729a	8000	8	M	277h44	BWF-MP1L2	32000	192	M	11h34
WAV-aLaw	48000	384	M	6h06	BWF-MP1L2	32000	192	S	11h34
WAV-aLaw	48000	768	S	3h03	BWF-MP1L2	32000	224	S	9h55
WAV-aLaw	44100	352	M	6h38	BWF-MP1L2	32000	256	S	8h40
WAV-aLaw	44100	705	S	3h19	BWF-MP1L2	32000	320	S	6h56
WAV-aLaw	32000	256	M	9h09	BWF-MP1L2	32000	384	S	5h47
WAV-aLaw	32000	512	S	4h34	BWF-PCM16	48000	768	M	2h53
WAV-aLaw	24000	192	M	12h12	BWF-PCM16	48000	1536	S	1h26
WAV-aLaw	24000	384	S	6h06	BWF-PCM16	44100	705	M	3h08
WAV-aLaw	22050	176	M	13h17	BWF-PCM16	44100	1411	S	1h34
WAV-aLaw	22050	352	S	6h38	BWF-PCM16	32000	512	M	4h20
WAV-aLaw	16000	128	M	18h18	BWF-PCM16	32000	1024	S	2h10
WAV-aLaw	16000	256	S	9h09	BWF-PCM16	24000	384	M	5h47
WAV-aLaw	12000	96	M	24h24	BWF-PCM16	24000	768	S	2h53
WAV-aLaw	12000	192	S	12h12	BWF-PCM16	22050	352	M	6h17
WAV-aLaw	11025	88	M	26h34	BWF-PCM16	22050	705	S	3h08
WAV-aLaw	11025	176	S	13h17	BWF-PCM16	16000	256	M	8h40
WAV-aLaw	8000	64	M	34h43	BWF-PCM16	16000	512	S	4h20
WAV-aLaw	8000	128	S	17h21	RAW-MP1L2	48000	32	M	69h26
WAV-uLaw	48000	384	M	6h06	RAW-MP1L2	48000	48	M	46h16
WAV-uLaw	48000	768	S	3h03	RAW-MP1L2	48000	56	M	39h40
WAV-uLaw	44100	352	M	6h38	RAW-MP1L2	48000	64	M	34h43

WAV-uLaw	44100	705	S	3h19	RAW-MP1L2	48000	64	S	34h43
WAV-uLaw	32000	256	M	9h09	RAW-MP1L2	48000	80	M	27h46
WAV-uLaw	32000	512	S	4h34	RAW-MP1L2	48000	96	M	23h08
WAV-uLaw	24000	192	M	12h12	RAW-MP1L2	48000	96	S	23h08
WAV-uLaw	24000	384	S	6h06	RAW-MP1L2	48000	112	M	19h50
WAV-uLaw	22050	176	M	13h17	RAW-MP1L2	48000	112	S	19h50
WAV-uLaw	22050	352	S	6h38	RAW-MP1L2	48000	128	M	17h21
WAV-uLaw	16000	128	M	18h18	RAW-MP1L2	48000	128	S	17h21
WAV-uLaw	16000	256	S	9h09	RAW-MP1L2	48000	160	M	13h53
WAV-uLaw	12000	96	M	24h24	RAW-MP1L2	48000	160	S	13h53
WAV-uLaw	12000	192	S	12h12	RAW-MP1L2	48000	192	M	11h34
WAV-uLaw	11025	88	M	26h34	RAW-MP1L2	48000	192	S	11h34
WAV-uLaw	11025	176	S	13h17	RAW-MP1L2	48000	224	S	9h55
WAV-uLaw	8000	64	M	34h43	RAW-MP1L2	48000	256	S	8h40
WAV-uLaw	8000	128	S	17h21	RAW-MP1L2	48000	320	S	6h56
BWF-MP1L2	48000	32	M	69h26	RAW-MP1L2	48000	384	S	5h47
BWF-MP1L2	48000	48	M	46h16	RAW-MP1L2	32000	32	M	69h26
BWF-MP1L2	48000	56	M	39h40	RAW-MP1L2	32000	48	M	46h16
BWF-MP1L2	48000	64	M	34h43	RAW-MP1L2	32000	56	M	39h40
BWF-MP1L2	48000	64	S	34h43	RAW-MP1L2	32000	64	M	34h43
BWF-MP1L2	48000	80	M	27h46	RAW-MP1L2	32000	64	S	34h43
BWF-MP1L2	48000	96	M	23h08	RAW-MP1L2	32000	80	M	27h46
BWF-MP1L2	48000	96	S	23h08	RAW-MP1L2	32000	96	M	23h08
BWF-MP1L2	48000	112	M	19h50	RAW-MP1L2	32000	96	S	23h08
BWF-MP1L2	48000	112	S	19h50	RAW-MP1L2	32000	112	M	19h50
BWF-MP1L2	48000	128	M	17h21	RAW-MP1L2	32000	112	S	19h50
BWF-MP1L2	48000	128	S	17h21	RAW-MP1L2	32000	128	M	17h21
BWF-MP1L2	48000	160	M	13h53	RAW-MP1L2	32000	128	S	17h21
BWF-MP1L2	48000	160	S	13h53	RAW-MP1L2	32000	160	M	13h53
BWF-MP1L2	48000	192	M	11h34	RAW-MP1L2	32000	160	S	13h53
BWF-MP1L2	48000	192	S	11h34	RAW-MP1L2	32000	192	M	11h34
BWF-MP1L2	48000	224	S	9h55	RAW-MP1L2	32000	192	S	11h34
BWF-MP1L2	48000	256	S	8h40	RAW-MP1L2	32000	224	S	9h55
BWF-MP1L2	48000	320	S	6h56	RAW-MP1L2	32000	256	S	8h40
BWF-MP1L2	48000	384	S	5h47	RAW-MP1L2	32000	320	S	6h56
BWF-MP1L2	32000	32	M	69h26	RAW-MP1L2	32000	384	S	5h47
BWF-MP1L2	32000	48	M	46h16					

WITHOUT EDITING FACILITY									
Recording	Sampling	Bitrate	Mono	Rec. T	Recording	Sampling	Bitrate	Mono	Rec. T
type	frequency		Stereo	On 2 GB	type	frequency		Stereo	On 2 GB
	Hz	kb/s	M / S	h m		Hz	kb/s	M / S	h m
RAW-MP1L3	48000	32	M	69h26	RAW-MP1L3	44100	112	S	19h50
RAW-MP1L3	48000	40	M	55h32	RAW-MP1L3	44100	128	M	17h21
RAW-MP1L3	48000	48	M	46h16	RAW-MP1L3	44100	128	S	17h21
RAW-MP1L3	48000	56	M	39h40	RAW-MP1L3	44100	160	M	13h53
RAW-MP1L3	48000	64	M	34h43	RAW-MP1L3	44100	160	S	13h53
RAW-MP1L3	48000	64	S	34h43	RAW-MP1L3	44100	192	M	11h34
RAW-MP1L3	48000	80	M	27h46	RAW-MP1L3	44100	192	S	11h34
RAW-MP1L3	48000	96	M	23h08	RAW-MP1L3	44100	224	S	9h55
RAW-MP1L3	48000	96	S	23h08	RAW-MP1L3	44100	256	S	8h40
RAW-MP1L3	48000	112	M	19h50	RAW-MP1L3	44100	320	S	6h56
RAW-MP1L3	48000	112	S	19h50	RAW-MP1L3	32000	32	M	69h26
RAW-MP1L3	48000	128	M	17h21	RAW-MP1L3	32000	40	M	55h32
RAW-MP1L3	48000	128	S	17h21	RAW-MP1L3	32000	48	M	46h16
RAW-MP1L3	48000	160	M	13h53	RAW-MP1L3	32000	56	M	39h40
RAW-MP1L3	48000	160	S	13h53	RAW-MP1L3	32000	64	M	34h43
RAW-MP1L3	48000	192	M	11h34	RAW-MP1L3	32000	64	S	34h43
RAW-MP1L3	48000	192	S	11h34	RAW-MP1L3	32000	80	M	27h46
RAW-MP1L3	48000	224	S	9h55	RAW-MP1L3	32000	96	M	23h08
RAW-MP1L3	48000	256	S	8h40	RAW-MP1L3	32000	96	S	23h08
RAW-MP1L3	48000	320	S	6h56	RAW-MP1L3	32000	112	M	19h50
RAW-MP1L3	44100	32	M	69h26	RAW-MP1L3	32000	112	S	19h50
RAW-MP1L3	44100	40	M	55h32	RAW-MP1L3	32000	128	M	17h21
RAW-MP1L3	44100	48	M	46h16	RAW-MP1L3	32000	128	S	17h21
RAW-MP1L3	44100	56	M	39h40	RAW-MP1L3	32000	160	M	13h53
RAW-MP1L3	44100	64	M	34h43	RAW-MP1L3	32000	160	S	13h53
RAW-MP1L3	44100	64	S	34h43	RAW-MP1L3	32000	192	M	11h34
RAW-MP1L3	44100	80	M	27h46	RAW-MP1L3	32000	192	S	11h34
RAW-MP1L3	44100	96	M	23h08	RAW-MP1L3	32000	224	S	9h55
RAW-MP1L3	44100	96	S	23h08	RAW-MP1L3	32000	256	S	8h40
RAW-MP1L3	44100	112	M	19h50	RAW-MP1L3	32000	320	S	6h56

WITHOUT EDITING FACILITY									
RAW-MP1L2	44100	32	M	69h26	BWF-MP1L2	44100	32	M	32
RAW-MP1L2	44100	48	M	46h16	BWF-MP1L2	44100	48	M	48
RAW-MP1L2	44100	56	M	39h40	BWF-MP1L2	44100	56	M	56
RAW-MP1L2	44100	64	M	34h43	BWF-MP1L2	44100	64	M	64
RAW-MP1L2	44100	64	S	34h43	BWF-MP1L2	44100	64	S	64
RAW-MP1L2	44100	80	M	27h46	BWF-MP1L2	44100	80	M	80
RAW-MP1L2	44100	96	M	23h08	BWF-MP1L2	44100	96	M	96
RAW-MP1L2	44100	96	S	23h08	BWF-MP1L2	44100	96	S	96
RAW-MP1L2	44100	112	M	19h50	BWF-MP1L2	44100	112	M	112
RAW-MP1L2	44100	112	S	19h50	BWF-MP1L2	44100	112	S	112
RAW-MP1L2	44100	128	M	17h21	BWF-MP1L2	44100	128	M	128
RAW-MP1L2	44100	128	S	17h21	BWF-MP1L2	44100	128	S	128
RAW-MP1L2	44100	160	M	13h53	BWF-MP1L2	44100	160	M	160
RAW-MP1L2	44100	160	S	13h53	BWF-MP1L2	44100	160	S	160
RAW-MP1L2	44100	192	M	11h34	BWF-MP1L2	44100	192	M	192
RAW-MP1L2	44100	192	S	11h34	BWF-MP1L2	44100	192	S	192
RAW-MP1L2	44100	224	S	9h55	BWF-MP1L2	44100	224	S	224
RAW-MP1L2	44100	256	S	8h40	BWF-MP1L2	44100	256	S	256
RAW-MP1L2	44100	320	S	6h56	BWF-MP1L2	44100	320	S	320
RAW-MP1L2	44100	384	S	5h47	BWF-MP1L2	44100	384	S	384

21 ALARMS

21.1 Low battery

If the machine is in stop, play or edit mode, a warning message “ Low power, please change batteries” appears for a few seconds. The Ares-M will continue to work for a few minutes. The battery icon will be shown empty.

If the machine is in the record mode, the led will light up twice per second instead of once every second. The battery icon will be shown empty.

21.2 Low memory

Once the free memory drops below 1 minute of recording, the led will light up twice per second instead of once every second. The remaining time on the display will show a figure below 1 minute.

22 DEFAULT SETTINGS

Screwdriver						
Select display language	English					
Set auto power down	30 sec					
Set screen save	30 sec					
Manager compress	Name	Core	SR	BR	EXT	
	HI QUALITY	WAV-PCM16	48000 Hz	1536 kbps ST	WAV	
	MUSIC	BWF-MP1L2	48000 Hz	256 kbps ST	BWF	
	SPEECH	BWF-MP1L2	48000 Hz	64 kbps MO	BWF	
	STENO	WAV-G729a	8000 Hz	8 kbps MO	WAV	
Manager input device	Name	Type	Gain	BST	PWR	FLT
	DYN	EXT-MIC	+ 6 dB	+34 dB	OFF	20-20 kHz
	NAGRA	EXT-MIC	+ 9 dB	+ 19 dB	ON	100-20 kHz
	COND	EXT-MIC	+ 9 dB	+ 19 dB	OFF	100-20 kHz
	INT	INT-MIC	+ 10 dB	OFF	OFF	OFF
	LINEH	LINE	+ 24 dB	OFF	OFF	OFF
	LINEL	LINE	+ 0 dB	OFF	OFF	OFF
Set speaker mode	Auto					
Lock input device gain	Disable					
Set record name prefix	USER					
Menu	Set input device	DYN				
	Set compress template	HI QUALITY				
	Set VOR mode	OFF				
	Set VOR stop mode	Pause REC				
	Set VOR stop delay	10 sec				
	Set AGC target	- 5 dB				
	Set pre-rec buffer	300 ms				
	Set work directory	ARESM				
Display	RECLV	+ 108.0 dB				
	VOL	- 9.0 dB				

23 MESSAGES

Message	Symptom	Solution
"Key is locked, can't power up!"	"Hold" key is engaged	Move the "Hold" switch to the other position
"If you want to change module, first stop recording!"	Features during record are blocked	Stop recording first and press the "C" key.
"Battery low power, will power off!"	Appears for a few seconds, just before switching off automatically due to low battery voltage. If this happens during record, the record stops and the file will be closed before power off.	Stop recording or use USB power. Replace batteries
"Disk is formatted!"	Appears for a few seconds if the memory is formatted.	
"Stop record"	Appears (including a timer) when the "STOP" key is pressed during a record.	
"Not enough disk space to save"	Insufficient free memory to save edited file.	Reduce file size or erase first other files
"Power off"	Appears (including a timer) when the "STOP" key is pressed to switch off the machine	

24 LANGUAGE TABLE

English ENG	Spanish SPA	French FRE	German DE
Pause REC	Pausa REC	Pause ENR	Pause REC
Split track	Nuevo	Nouveau	Neue Datei
Cancel	Anula	Annul.	Abbruch
5 sec	5 sec	5 sec	5 sek
10 sec	10 sec	10 sec	10 sek
15 sec	15 sec	15 sec	15 sek
20 sec	20 sec	20 sec	20 sek
Cancel	Anula	Annul.	Abbruch
-5 dBFS	-5 dBFS	-5 dBFS	-5 dBFS
-8 dBFS	-8 dBFS	-8 dBFS	-8 dBFS
-11.5 dBFS	-11.5 dBFS	-11.5 dBFS	-11.5 dBFS
-14 dBFS	-14 dBFS	-14 dBFS	-14 dBFS
Cancel	Anula	Annul.	Abbruch
500 ms	500 ms	500 ms	500 ms
1000 ms	1000 ms	1000 ms	1000 ms
1.5 sec	1.5 sec	1.5 sec	1.5 sek
2 sec	2 sec	2 sec	2 sek
3 sec	3 sec	3 sec	3 sek
Cancel	Anula	Annul.	Abbruch
No loop	Sin bucle	Non	No Loop
Current	Actual	En cours	Datei
Order	Orden	Ordre	Liste
Random	Casual	Aléa.	Zufall
Set input device	Dispositivo entrada	Entrée	Eingang
Set compress template	Formato plantilla	Format fichier	Dateiformat
Set VOR mode	Modo VOR	VOR	VOR
Set VOR stop mode	Modo parada VOR	Mode VOR	VOR Stop Modus
Set VOR stop delay	Retardo parada VOR	Délai VOR	VOR Stop Delay
Set AGC target level	Nivel límite AGC	Niveau AGC	AGC Pegel
Set pre-rec buff	Memoria pregrabación	Mémoire tampon	Pre-Rec Buffer
Set Loop mode	Modo bucle	Bouclage lecture	Loop Modus
Set work directory	Carpeta de trabajo	Dossier de travail	Arbeitsordner

Confirm	Acepta	Oui	OK
Cancel	Anula	Non	Stop
DELE	Borra	Eff.	Ja
Confirm file delete ?	Acepta borrar archivo?	Confirmer effacer ?	Wirklich löschen?
Don't change settings in record!	No cambia preajustes en grabación	Modification des paramètres impossible !	Einstellungen bei Aufnahme nicht verändern!
If you want to change module, first stop recording!	Pare la grabación si quiere cambiar el módulo!	Arrêt de l'enregistrement avant modification	Um Einstellungen zu ändern Aufnahme beenden!
Play	Lee	Lecture	Play
Erase	Borra	Effacer	Löschen
Edit	Edita	Montage	Edit
Wipe	Limpiar	Sauver	Wipe
Copy to...	Copia a...	Copier...	Kopieren
Move To...	Mueve a...	Déplacer...	Bewegen
Make dir	Crea dir	Créer	New Dir
Rename	Renombra	Renommer	Rename
Return	Vuelve	Retour	Zurück
Play	Lee	Lecture	Play
Erase	Borra	Effacer	Löschen
Copy to...	Copia a	Copier...	Kopieren
Move to...	Mueve a	Déplacer...	Bewegen
Make dir	Crea dir	Créer	New Dir
Rename	Renombra	Renommer	Rename
Return	Vuelve	Retour	Zurück
Erase	Borra	Effacer	Löschen
Copy to...	Copia a	Copier...	Kopieren
Move to...	Mueve a	Déplacer...	Bewegen
Make dir	Crea dir	Créer	New Dir
Rename	Renombra	Renommer	Rename
Return	Vuelve	Retour	Zurück
Entry	Entra	Entrée	Enter
Play	Lee	Lecture	Play
Erase	Borra	Effacer	Löschen
Make dir	Crea dir	Créer	New Dir
Rename	Renombra	Renommer	Rename
Return	Vuelve	Retour	Zurück
Make dir	Crea dir	Créer	New Dir
Return	Vuelve	Renommer	Zurück
Return	Vuelve	Retour	Zurück
Make dir	Crea dir	Créer	New Dir

Cancel	Anula	Annul.	Abbruch
Return	Vuelve	Retour	Zurück
File or directory not found	Archivo o directorio no encontrado	Non trouvé	Datei oder Ordner nicht gefunden
Erasing failed	Error al borrar	Efface. Échoué	Löschen fehlgeschlagen
Folder isn't empty, operation failed	Archivo no vacío, operación fallada	L'action a échoué, dossier non vide	Ordner nicht leer, Vorgang fehlgeschlagen
NEWDIR	NUEVODIR	NOUVEAU	NEU
File operating path error!	Error dirección archivo	Chemin incorrect !	Dateipfad fehlerhaft
Failed to copy file!	Error al copiar archivo	La copie a échoué !	Kopieren fehlgeschlagen!
Failed to move file!	Error al mover archivo	Erreur déplacement !	Bewegen fehlgeschlagen!
Confirm del. directory and file(s)?	Confirmar borrar directorio y archivo(s)	Confirmer l'effacement ?	Löschen bestätigen!
English	English	English	English
Français	Français	Français	Français
Deutsch	Deutsch	Deutsch	Deutsch
Polski	Polski	Polski	Polski
Español	Español	Español	Español
中文	中文	中文	中文
Nederlands	Nederlands	Nederlands	Nederlands
Cancel	Anula	Annul.	Abbruch
15 sec	15 sec	15 sec	15 sek
30 sec	30 sec	30 sec	30 sek
45 sec	45 sec	45 sec	45 sek
1 min	1 min	1 min	1 min
2 min	2 min	2 min	2 min
Disable	Inhâbil	Non	Aus
Cancel	Anula	Annul.	Abbruch
15 sec	15 sec	15 sec	15 sek
30 sec	30 sec	30 sec	30 sek
45 sec	45 sec	45 sec	45 sek
1 min	1 min	1 min	1 min
2 min	2 min	2 min	2 min
Disable	Inhâbil	Non	Aus
Cancel	Anula	Annul.	Abbruch
Off	Apagado	Non	Aus
Auto	Auto	Auto	Auto
Cancel	Anula	Annul.	Abbruch
Reset counter	Puesta a cero	Oui	Reset
Cancel	Anula	Annul.	Abbruch
Format	Formato	Format	Löschen

Cancel	Anula	Annul.	Abbruch
Entry	Entra	Entrée	Reset
Cancel	Anula	Annul.	Abbruch
Manual	Manual	Non	Unlock
Lock	Bloquear	Oui	Lock
Cancel	Anula	Annul.	Abbruch
Select display language	Selección idioma	Langues	Sprache
Set auto power down	Ajuste apagado automático	Extinction automatique	Auto Power Down
Set screen save	Ajuste salvapantalla	Economiseur d'écran	Screen Saver
Manager compress template	Gestión plantillas	Formats fichiers	Dateiformate
Manager input device	Gestión útiles entrada	Gestion entrées	Eingangsquellen
Set speaker mode	Modo escucha	Haut-parleur	Lautsprechermodus
Clear record counter	Contador grabación a cero	Raz compteur	Reset Counter
Lock input device gain	Bloqueo ganancia útiles	Verrouillage gain	Lock Gain
Set record name prefix	Prefijo nombres archivos	Entrée préfixe	Präfix Dateinamen
Set date and time	Fecha y hora	Date & heure	Datum und Uhrzeit
Restore factory settings	Restaurar ajustes fábrica	Paramètres usine	Werkseinstellung
Format disk	Formatear disco	Formatage	Speicher löschen
Check disk space	Comprobar espacio disco	Espace disque	Freier Speicher
Check software ver	Versión programa	Version logicielle	Softwareversion
Check machine ID	ID máquina	Identifiant ARES	Geräte ID
File counter is cleared!	Contador a cero!	Le compteur est à 0 !	Counter reset!
Disk is formatted!	Disco formateado!	Disque formaté !	Speicher gelöscht!
Formatting failed!	Error formateado!	Erreur formatage !	Löschfehler!
New name	Nuevo nombre	Nouveau	Neuer Name
Template manage	Gestión plantillas	Gestion mémoires	Format verwalten
Input device manage	Gestión entradas	Gestion des entrées	Eingänge verwalten
Input record prefix	Prefijo grabación	Entrée du préfixe	Präfix eingeben
USB Power	Alimentación USB	Alim. USB	USB Power
USB Transfer	Volcado USB	Transfert USB	USB Transfer
USB Charge	Carga USB	Charge USB	USB Akku Laden
Key is locked, please unlock first!	Teclado bloqueado, pf, desbloquee!	Déverrouiller clavier !	Bitte erst entriegeln!
Key is locked, can't power up!	Teclado bloqueado, no arranca!	Clavier verrouillé !	Kann nicht einschalten, bitte entriegeln!
Stop record	Para grabación	Stopper l'enr.	Stop Record
Battery low power, will power off!	Batería baja, se apagará	Batterie vide, extinction !	Batterie leer, schalte ab!
Can't start record, because disk is full!	imposible iniciar grabación, disco lleno	Disque plein !	Speicher ist voll, keine Aufnahme möglich!
Save	Guarda	Sauve	Save
Don't	No	Non !	Don't
Don't you save before quit?	Guardar antes de salir?	Sauver avant de quitter ?	Änderungen speichern?

Not enough disk space to save audio file!	Sin espacio para guardar archivo audio	Espace disque insuffisant !	Nicht genügend Speicherplatz!
Jump position	Salto de posición	Saut position	Springe zu
Jump pos. error	Err. salto de pos.	Erreur position	Position Error
Data will be lost!	Pérdida datos	Tout sera effacé !	Datenverlust!
Please confirm?	Confirme, pf	Confirmer ?	Bestätigen?
Cut operation failed!	Error corte edición	Le montage a échoué !	Schnitt nicht möglich!
Low power, please change battery!	Batería baja, pf cambialas	Changer la batterie !	Batterie ist bald leer, bitte erneuern!
No File	Vacio	Vide	Keine Datei
Resume factory setting!	Puesta a punto origen!	Paramètres par défaut !	Werkseinstellungen!
Date setting	Fecha actual	Entrée date	Datum setzen
File counter to be reset!	Contador ficheros a cero!	Le compteur sera raz !	Counter Reset?
System update	Actualización sistema	Mise à jour du soft	Software Update
1 Check battery power	1 Estado batería	1 Vérifier piles	1.Batterie prüfen
2 Plug in USB cable	2 Conecte cable USB	2 Brancher câble USB	2.USB-Kabel verbinden
3 Copy "APP.COE"	3 Copie "APP.COE"	3 Copier "APP.COE"	3."APP.COE" kopieren
4 Remove USB cable	4 Retire el cable USB	4 Enlever câble USB	4.USB-Kabel entfernen
5 Wait for shutdown	5 Espere para apagar	5 Extinction	5.Endabschaltung
6 Turn on the device	6 Encienda la unidad	6 Allumer l'appareil	6.Einschalten
Set record mode	Modo de registro	Mode de sortie	Aufnahme Modos setzen
Normal	Directo	Direct	Normal
Tape mode	Regreso	Retour	Band Modus
Undo list	Deshaga lista	Liste des annulations	Undo Liste
Marker list	Lista de marcador	Liste des marqueurs	Marker Liste
Zoom	Zoom	Zoom	Zoom
Set search speed	Elegir velocidad	Vitesse <<, >>	Setze Such Speed
Set input matrix	Matriz entrada	Matrice d'entrée	Setze Inp Matrix
Auto	Auto	Auto	Auto
Double Ch	2 Canales	Stéréo	Zweikanal
Mono L	Mono izdo	Mono G	Mono L
Marker not found	Marca no localizada	Marqueur non trouvé	Marker nicht gefun.
Undo list not found	Lista deshacer perdida	Undo non trouvé	UndoList nicht gef.
Selection is saved as file xxxx.xx	Selección guardada como xxxx.xx	Sauvegarde sous xxxx.xx	Auswahl gespeichert unter xxxx.xx
Save selection to a new file	Guardar selección en nuevo archivo	Sauvegarder la sélection	Auswahl speichern unter
Confirm operation?	Confirma operación?	Confirmer ?	Vorgang bestätig.?
Create marker at current position!	Crear marca en posición actual	Créer un marqueur ici !	Marker gesetzt!
VOR off	Desconectar VOR	VOR coupé	VOR aus
OK key in record	Modo boton OK en REC	Touche OK en ENR.	OK während Aufnahme
Pause record	Pausa	Pause	Pause REC
Next record	Nuevo archivo	Nouveau fichier	Next REC

STOP key in record	Retardo STOP en REC	Délai STOP en ENR.	STOP während Aufnahme
Timer on	Si	Oui	Timer An
Timer off	No	Non	Timer Aus
Save as a new file	Salvar como nuevo a.	Sauver comme nouveau f.	Save neue datei
Set display brightness	Luminosidad pantalla	Luminosité	Display Helligkeit
Low memory, < 1 min!	Memoria baja, < 1min!	Temps restant, moins d'1 mn!	Speicher bald voll, < 1 min!

English ENG	Polish PL	Dutch NL
Pause REC	Pauza REC	Pauze OPNAME
Split track	Dziel ślad	Splits
Cancel	Cofnij	Annuleer
5 sec	5 sek	5 sec
10 sec	10 sek	10 sec
15 sec	15 sek	15 sec
20 sec	20 sek	20 sec
Cancel	Cofnij	Annuleer
-5 dBFS	-5 dBFS	-5 dBFS
-8 dBFS	-8 dBFS	-8 dBFS
-11.5 dBFS	-11.5 dBFS	-11.5 dBFS
-14 dBFS	-14 dBFS	-14 dBFS
Cancel	Cofnij	Annuleer
500 ms	500 ms	500 ms
1000 ms	1000 ms	1000 ms
1.5 sec	1.5 sek	1.5 sec
2 sec	2 sek	2 sec
3 sec	3 sek	3 sec
Cancel	Cofnij	Annuleer
No loop	Brak	Niet herhalen
Current	Bieżąca	Huidig
Order	Ustalona	In volgorde
Random	Losowa	Willekeurig
Set input device	Wybór wejścia	Ingangsbron
Set compress template	Wybór kompresji	Compressie
Set VOR mode	Ustaw tryb VOR	VOR mode
Set VOR stop mode	Ustaw stop VOR	VOR stop mode
Set VOR stop delay	Ustaw opóźnienie VOR	VOR stop vertraging
Set AGC target level	Ustaw poziom AGC	AGC doelniveau

Set pre-rec buff	Ustaw bufor nagrania	Opnamebuffer
Set Loop mode	Ustaw tryb pętli	Herhalen
Set work directory	Ustaw folder roboczy	Actieve map
Confirm	Akcept.	Bevestig
Cancel	Cofnij	Annuleer
DELETE	USUŃ	WIS
Confirm file delete ?	Czy usunąć plik?	Bevestig wissen
Don't change settings in record!	Nie zmieniać ustawień nagrania!	Instellingen niet veranderen tijdens opname!
If you want to change module,first stop recording!	Aby zmienić tryb zatrzymaj nagranie!	Voor aanpassing instellingen, opname beëindigen!
Play	Odtwórz	Weergave
Erase	Kasuj	Wis
Edit	Edytuj	Bewerk
Wipe	Zmaż	Bouw
Copy to...	Kopiuji	Kopieer naar...
Move To...	Przenieś	Verplaats naar...
Make dir	Utwórz	Maak map
Rename	Zmień	Herbenoem
Return	Powrót	Terug
Play	Odtwórz	Weergave
Erase	Kasuj	Wis
Copy to...	Kopiuji	Kopieer naar...
Move to...	Przenieś	Verplaats naar...
Make dir	Utwórz	Maak map
Rename	Zmień	Herbenoem
Return	Powrót	Terug
Erase	Kasuj	Wis
Copy to...	Kopiuji	Kopieer naar...
Move to...	Przenieś	Verplaats naar...
Make dir	Utwórz	Maak map
Rename	Zmień	Herbenoem
Return	Powrót	Terug
Entry	Wejście	Ingave
Play	Odtwórz	Weergave
Erase	Kasuj	Wis
Make dir	Utwórz	Maak map
Rename	Zmień	Herbenoem
Return	Powrót	Terug
Make dir	Utwórz	Maak map

Return	Powrót	Terug
Return	Powrót	Terug
Make dir	Utwórz	Maak map
Cancel	Cofnij	Annuleer
Return	Powrót	Terug
File or directory not found	Brak pliku lub folderu	Bestand of map niet gevonden
Erasing failed	Błąd kasowania	Wissen mislukt
Folder isn't empty, operation failed	Niepusty folder-błąd operacji	Map is niet leeg, bewerking mislukt
NEWDIR	FOLDER	NIEUW
File operating path error!	Błąd ścieżki dostępu!	Actieve map fout!
Failed to copy file!	Błąd kopiowania pliku!	Kopie mislukt!
Failed to move file!	Błąd przeniesienia pliku!	Verplaatsen bestand mislukt!
Confirm del. directory and file(s)?	Czy usunąć folder i pliki?	Bevestig wissen map of bestand?
English	English	English
Français	Français	Français
Deutsch	Deutsch	Deutsch
Polski	Polski	Polski
Español	Español	Español
中文	中文	中文
Nederlands	Nederlands	Nederlands
Cancel	Cofnij	Annuleer
15 sec	15 sek	15 sec
30 sec	30 sek	30 sec
45 sec	45 sek	45 sec
1 min	1 min	1 min
2 min	2 min	2 min
Disable	Wyłącz	Uit
Cancel	Cofnij	Annuleer
15 sec	15 sek	15 sec
30 sec	30 sek	30 sec
45 sec	45 sek	45 sec
1 min	1 min	1 min
2 min	2 min	2 min
Disable	Wyłącz	Uit
Cancel	Cofnij	Annuleer
Off	Wyłącz	Uit
Auto	Auto	Automatisch
Cancel	Cofnij	Annuleer
Reset counter	Zeruj licznik	Herstel teller

Cancel	Cofnij	Annuleer
x		
Format	Format	Formaatteer
Cancel	Cofnij	Annuleer
Entry	Wej.	Ingave
Cancel	Cofnij	Annuleer
Manual	Ręczny	Handmatig
Lock	Blokuj	Blokkeer
Cancel	Cofnij	Annuleer
Select display language	Wybór języka	Taalkeuze
Set auto power down	Ustaw autowylączenie	Automatisch uitschakelen
Set screen save	Ustaw wył. wyświetlacza	Schermbeweiiging
Manager compress template	Ustaw szablon kompresji	Beheer compressie
Manager input device	Ustaw urząd. wejścia	Beheer ingangsbron
Set speaker mode	Ustaw tryb głośnika	Kies luidsprekermodus
Clear record counter	Zeruj licznik nagrań	Zet teller op 0
Lock input device gain	Blokada wzmocnienia wej.	Vergrendel ingangsgoedigheid
Set record name prefix	Ustaw prefiks nazwy nagr.	Kies opnamenaam
Set date and time	Ustaw datę i czas	Datum en tijd
Restore factory settings	Przywróć ustawienia fabr.	Herstel fabrieksinstellingen
Format disk	Formatuj dysk	Formaatteer schijf
Check disk space	Sprawdź pojemność dysku	Controleer schijfruimte
Check software ver	Sprawdź wersję oprogram.	Softwareversie
Check machine ID	Sprawdź ID urządzenia	Identificatie toestel
File counter is cleared!	Licznik wyzerowany!	Teller is hersteld!
Disk is formatted!	Dysk sformatowany	Schijf is geformateerd!
Formatting failed!	Błąd formatowania!	Formatteren mislukt!
New name	Nazwa	Nieuwe naam
Template manage	Szablony	Beheer sjablonen
Input device manage	Ustaw urząd. wej.	Beheer ingangsbronnen
Input record prefix	Prefiks nagrania	Opnamenaam
USB Power	Zasilanie USB	USB-voeding
USB Transfer	Transm. USB	USB-overdracht
USB Charge	Ładow. USB	USB-laden
Key is locked, please unlock first!	Odblokuj klawiaturę!	Vergrendeld, eerst ontgrendelen!
Key is locked, can't power up!	Blokada zasilania!	Vergrendeld, inschakelen onmogelijk!
Stop record	Stop nagrania	Stop opname
Battery low power, will power off!	Słaba bateria!	Batterij bijna leeg, ik schakel uit!
Can't start record, because disk is full!	Dysk zapelniony!	Ik kan niet opnemen, schijf is vol!

Save	Zapis	Sla op
Don't	Nie	Neen
Don't you save before quit?	Czy zapisać przed wyjściem?	Opslaan voor afsluiten?
Not enough disk space to save audio file!	Za mała pojemność dysku!	Niet genoeg schijfruimte om op te slaan!
Jump position	Omiń pozycję	Ga naar
Jump pos. error	Błąd pozycji	Positiefout
Data will be lost!	Utracisz dane!	Gegevens zullen verloren gaan!
Please confirm?	Potwierdzasz?	Bevestig aub!
Cut operation failed!	Błąd przy "wytnij"!	Knippen mislukt!
Low power, please change battery!	Zmień baterię!	Lage spanning, verwissel batterijen aub!
No File	Brak	Geen bestand
Resume factory setting!	Ustawienia fabryczne	Keer terug naar fabrieksinstellingen!
Date setting	Ustaw datę	Datum & tijd
File counter to be reset!	Zeruję licznik plików!	Teller weer op nul zetten!
System update	Aktualizacja systemu	Vernieuw software
1 Check battery power	1 Sprawdź baterię	1 Controleer batterijen
2 Plug in USB cable	2 Włącz kabel USB	2 Verbind de USB kabel
3 Copy "APP.COE"	3 Kopiuj "APP.COE"	3 Kopieer "APP.COE"
4 Remove USB cable	4 Usuń kabel USB	4 Verwijder de USB-kabel
5 Wait for shutdown	5 Oczekuj wyłączenia	5 Wacht op uitschakeling
6 Turn on the device	6 Włącz urządzenie	6 Zet het toestel aan
Set record mode	Tryb nagrania	Opnamemodus
Normal	Zwykły	Normaal
Tape mode	Taśmy	Bandopnememodus
Undo list	Cofnięcia	Lijst ongedaan maken
Marker list	Znaczniki	Lijst markers
Zoom	Zoom	Zoomen
Set search speed	Pręđ. przeglądu	Zoeksnelheid
Set input matrix	Matryca wejść	Ingangsmatrix
Auto	Auto	Automatisch
Double Ch	Dwa kan.	Stereo
Mono L	Mono L	Mono L.
Marker not found	Brak znaczników	Geen marker
Undo list not found	Brak listy cofnięć	Geen herstellijst
Selection is saved as file xxxx.xx	Wybór zapisany jako xxxx.xx	Selectie opgeslagen als xxxx.xx
Save selection to a new file	Zapisz wybór do pliku	Bewaar selectie als nieuw bestand
Confirm operation?	Czy potwierdzasz?	Bevestig bewerking ?
Create marker at current position!	Wstaw znacznik!	Plaats hier een marker !
VOR off	Wył. VOR	VOR uit

OK key in record	OK dla nagrania	OK toets tijdens rec.
Pause record	Pauza	Pause opname
Next record	Nowe nagranie	Volgende opname
STOP key in record	STOP dla nagrania	STOP toets tijdens rec.
Timer on	Wł timer	Timer aan
Timer off	Wył timer	Timer uit
Save as a new file	Zapisz jako nowy plik	Opslaan als nieuw best.
Set display brightness	Ustaw jasność wyświetlacza	Scherminhoud +/-
Low memory, < 1 min!	Uwaga, ostatnia min. nagrania!	Geheugen, < 1 min!

25 SPECIFICATIONS

GENERAL

Data Storage medium	Built-in 1GB memory FAT 16
Recording Method	Digital (PCM) or Digital compression
Compression type	ISO MPEG 1 Layer II / III
A/D & D/A, PCM, MPEG conversion	24 bit Philips UDA1380
File Format	16 Bit Wave Format (xxx.WAV) or MPEG Raw (xxx.MP2, xxx.MP3)
Sampling Rate	From 8 to 48 kHz
Compress Bit-Rates	32 to 384 kb/s
Mono/Stereo	Switchable
Recording Capacity	1 hour 26 minutes Stereo 48 kHz PCM 36 hours 57 minutes Mono 48 kHz, 64 kb/s
Dynamic Range Adjustment	50 dB for 0 dB record
Filters	"Flat", "LFA"
Automatic Gain Control	"ON", "OFF" (Target level adjustable)

INPUTS

Built-in Mike	Electret
Mike Inputs	3.5 mm stereo jack connector
Mike Powering	3V Electret
Mike Input Sensitivity	Minimum 1.5 mV for full scale
Line Input	3.5 mm stereo jack connector
Line Input Sensitivity, Low & High Range	19 mV to 4.9 V for 0 dB recording

OUTPUTS

Headphone	3.5 mm stereo jack connector
Line Output	3.5 mm stereo jack connector
Line Output Level	Maximum 0.9 V
THD at 1 kHz	0.1 %
Frequency Response	30 Hz – 20 kHz (-3 dB in EE mode)
Total Dynamic Range Line Output	Up to 80 dB
Total Dynamic Range On Recorded File	Up to 90 dB
Built-in Speaker	0.1 W
USB	V1.1

POWER SUPPLY

Internal Batteries	2 x "AA" cells
Consumption	3 V, maximum 100 mA (approx. 10 hours)

PHYSICAL

Dimensions	125 x 53 x 23 mm (5 x 2 x 1 in) w/o plug-on mike
Weight	150g, (0.33 lb) incl. batteries, w/o plug-on mike

26 DECLARATION OF CONFORMITY

DECLARATION DE CONFORMITE DECLARATION OF CONFORMITY



FABRICANT: Infomedia & Phihong pour NAGRAVISION
MANUFACTURER: *Infomedia & Phihong for NAGRAVISION*

APPAREIL : ARES-M & alimentation PSC03R-050
MODEL: *ARES-M & power supply PSC03R-050*

NORMES APPLICABLES :
APPLICABLE NORMS:

Champ électromagnétique rayonné
Radiated electromagnetic field EN 55022 Cl. B
EN 55022 Cl. B

Immunité aux champs électromagnétiques
Immunity to electromagnetic fields EN 61000-4-3
EN 61000-4-3

Immunité aux décharges électrostatiques
Immunity to electrostatic discharges EN 61000-4-2
EN 61000-4-2

Immunité aux aux transitoires électriques
rapides en salves sur câbles d'entrées/sorties
(500V)
*Immunity to burst on input/output signal line
(500V)* EN 61000-4-4 level 1
EN 61000-4-4 level 1

Cheseaux 4^{ème} trimestre 2005
Cheseaux 4th quarter 2005

Signature

Gestion des déchets d'équipements électriques et électroniques
Regulation on waste electrical and electronic equipment

En fin de vie de l'appareil, amener à un centre de récupération des déchets.
*This product contains elements that could harm the environment. Please dispose of it
through an appropriate recycling centre.*



26 INDEX TABLE

AGC, 8, 10, 12, 14, 40
Auto, 16, 21, 24, 40
Auto power, 21
Batteries, 57
Bitrate, 22, 36, 38
Compression, 12, 14, 57
Copy, 35
Date, 24
Disk, 25, 41
Entering, 18
Erasing, 17, 18
Filter, 10
Format, 25, 57
Front panel, 7
Headphone, 8, 57
Identification, 5
Input, 10, 12, 14, 22, 23, 24, 30, 31, 57
Input device, 12, 14, 22, 23, 24, 30, 31
Input gain, 23
Input sensitivity, 24
MAC, 8, 11, 34, 35
Marker, 26, 27
Menu, 8, 15, 28, 40
Mic, 9, 31
Microphone, 31
Modulometer, 11, 26
Move, 7, 29, 41
MP2, 32, 33, 57
MP3, 32, 33
Pause, 7, 11, 13, 15, 40
PC, 8, 11, 17, 34, 35
Play, 7, 9, 11, 26
Playback, 13, 16, 26, 27
Pre-rec, 12, 13
Record, 10, 11, 14, 24, 40
Record level, 10
Renaming, 17
Sampling frequency, 15, 22
Screen save, 21
Software, 1, 6, 25
Software update, 6
SOFTWARE UPDATE, 35
Speaker, 24, 57
Stop, 7, 9, 11, 29, 41
Template, 12, 15, 21
Templates, 14, 21
Time, 24
updating, 35
USB, 8, 11, 18, 31, 33, 34, 35, 41
Voice, 11, 13, 15
VOR, 11, 13, 15, 16, 40

NAGRAVISION SA KUDELSKI GROUP
Route de Genève 22
CH-1033 Cheseaux
Switzerland

Phone +41 (0)21 732-0101
Fax +41 (0)21 732-0100
E-mail: audio_pro@nagra.com

All rights reserved-© July, 2007