

SDA102™

INSTANT DELAY

www.Sabine.com

OPERATING GUIDE

INSIDE THIS GUIDE:

SDA-102 Controls	2
Digital Delay Advantage	3-6
Delay Applications	6-8
Calculating Delay Time	9
Basic Operating Instructions	9
Engineering Specifications	10
FCC Information	10
Safety Information	11
Warranty	12



SDA-102
Front Panel

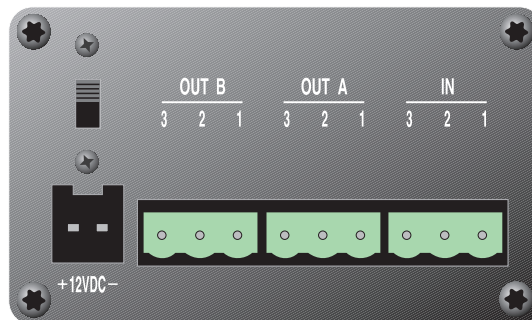

SDA-102
Back Panel

CONGRATULATIONS! You have chosen the ultimate digital delay for acoustical alignment of speaker systems in auditoriums, churches, stadiums, theaters, conference rooms, and venues of all sizes and designs. For an explanation of the digital delay solution and advantage, see page 3. For the delay application guide, turn to page 6.

Special features of the SDA-102 Instant Delay:

- One input, two outputs
- 20-bit A/D & D/A converters with 24-bit digital processing
- Up to 999.98 millisecond delay
- 20 microsecond resolution
- Input and output level controls
- Front panel lockout
- Optional rack tray holds up to six units

SDA-102 Front & Back Panels

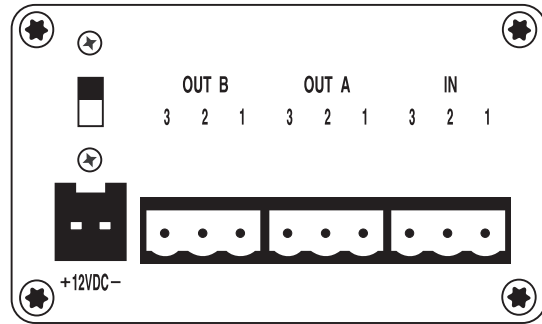
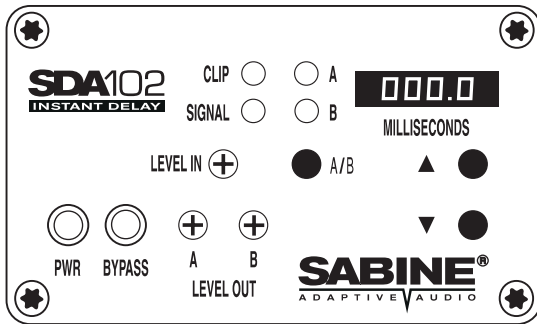

POWER

The ON/OFF power switch is a two-position push button switch. The LED display illuminates on power-up.

ACTIVE/BYPASS

In Active mode, the unit delays the input signal. When the BYPASS button is depressed, the unit is in Bypass mode. If the unit is turned off, it must be in Bypass to pass audio.

INPUT LEVEL CLIP INDICATOR

The red clip LED comes on when the input level is 6dB below clipping level. Adjust the clip IN so that the SDA's red clip LED blinks intermittently during maximum program levels. Higher levels cause clipping and distortion, and lower levels introduce noise.

SIGNAL INDICATOR

The SIGNAL LED lights when the signal level is above -30dB of clip level.

LEVEL IN

Use a small flathead screwdriver to increase or decrease the input level.

LEVEL OUT A/B

The output level for channels A and B can be adjusted individually. Use a screwdriver to increase or decrease the output level for either channel. The output level is adjustable from 0 to 100%. Full output level is +26dBV into 600 Ohms, balanced. Peak output capability is +29dBV peak, balanced.

A/B SELECT & CHANNEL INDICATORS

This push button allows you to set delay time for channels A and B separately. Select a channel using the A/B button, and the corresponding channel indicator LED will light red. Then use the arrow keys to adjust the delay time for that channel.

UP/DOWN ARROWS

Use the arrow keys to increase or decrease delay time (in milliseconds) for either channel individually.

LED DISPLAY

The four-digit LED display shows delay time in milliseconds.

FRONT PANEL LOCKOUT SWITCH

The unmarked switch at the upper left of the back panel is the front panel lockout switch. When in the UP position, the unit is unlocked (default) and anyone can adjust the SDA's controls. When the switch is in the DOWN position, the unit is locked, and the delay time can't be changed.

12VDC ADAPTOR

The SDA external power supply is included with the unit. Use of any other power supplies may cause fire, injury or permanent damage to the unit and **WILL VOID THE WARRANTY**.

INPUT/OUTPUT CONNECTORS

The SDA includes three Euroblock three-pin connectors. The numbers 3-2-1 marked above the connectors refer to LOW (3) - HIGH (2) - SHIELD (1).

.....

THE DIGITAL DELAY ADVANTAGE: Synchronize loudspeakers, eliminate comb filter distortion, align the acoustic image

Special thanks to Hans Drobilitzsch of Hans Drobilitzsch Audio GmbH. (Wollersdorf, Austria) for his invaluable technical advice.

Why Digital Delays?

The most intelligible sound occurs when two people speak face to face. The sound is loud and dry and the direction of the sound aligns with the speaker. It stands to reason that the most intelligible sound systems are the ones that come closest to emulating face to face communication. If this is your goal, a digital delay is essential to your sound system.

Until recently, a digital delay's cost was prohibitive for the average user. Only high-end applications could justify the cost. But recent drops in component prices now put the benefits of digital delays within affordable reach of every user.

There are three distinct applications for digital delays. The first and most important is **synchronization of the loudspeakers** to control excess reverberation and echo. Secondly, digital delays help **control comb filter distortion**, and finally, digital delays are useful for **aligning the acoustic image** so the direction of the sound seems to be coming from the performer rather than the loudspeaker.

This manual goes beyond the typical operating guide that only explains the front and back panel adjustments. Instead, we discuss the basic acoustical concepts needed to get the most out of your SDA-102 and present examples of several practical applications.

Loudspeaker Synchronization

Sound travels at about 1,130 feet per second in air, or about 1 millisecond per foot. On the other hand, electronic signals travel almost one million times faster through your sound system to the loudspeakers. The main task of digital delays is to synchronize multiple loudspeakers so the sound traveling different distances arrives at the listener's ears at about the same time. Synchronizing the loudspeakers reduces reverberation and echoes for improved intelligibility.

How to Synchronize Your Signals

There are several powerful tools available for precisely measuring the time a loudspeaker signal takes to arrive at a certain point in the audience. Most of these tools are very sophisticated and tend to be quite expensive. Fortunately, simpler tools are sufficient for most applications.

In the 1930's, engineers synchronized the low and high frequency speakers in movie theaters by feeding a sharp click through the system. They moved the speakers until they could only hear a single sharp click coming from both speakers. You can use this same method with a common child's toy called a clicker. Pressing the thin metal strip makes a loud sharp click. A clicker is especially useful when synchronizing the direct sound from the performer with the sound from the loudspeakers.

Alternatively, you can use a phase checker especially for synchronizing the signals of two loudspeakers (either LF and HF or two full range systems) since most of the phase checkers include a click generator and receiver. Phase checkers are quite affordable and have other uses besides synchronizing.

Processing (or Group) Delays

Converting signals back and forth from the analog to digital domain always delays the signal a little. These conversion delays are often called processing (or group) delays, and usually range between 0.9 to 5 milliseconds. You will notice that Sabine delays always display the processing delay as the smallest possible delay value. For the SDA-102, the processing delay is 0.9 milliseconds. You can simply bypass the unit for 0 seconds delay.

Not all manufacturers acknowledge processing delays in their specifications, but you must take them into account when synchronizing your system. Make sure all digital equipment is on and not bypassed when synchronizing. Also, be careful to make an appropriate adjustment in your delay lines if you later add any type of digital equipment to the system.

Center Cluster Speakers

Center cluster speakers offer several advantages over systems that have speakers mounted on the sides. The most obvious advantage is that the distance to the closest and most distant locations in the audience is almost equal, so most listeners hear about the same level. Center clusters also offer two other advantages regarding the visual imaging.

Studies have shown that people can detect even small horizontal changes in the direction of a sound source, but vertical shifts are much less noticeable. This suggests that the sound from center-cluster speakers is more likely to be visually aligned with the performer than loudspeakers placed on each side of the stage.

All those in the audience who are closer to the performer than the center cluster will hear the direct sound from the performer before they hear the sound from the loudspeakers. This makes the sound seem to come from the performer, not the loudspeakers. (See the Precedence Effect below.)

Comb Filter Distortion

Many who took high school science may remember ripple tank experiments where waves are generated from two separate point sources. The waves from each source combine to form visible interference patterns. In some places, the wave crests and troughs are in phase so they combined to make a larger wave. In other places the crests are out of phase, so the crest of one wave source is canceled by the trough of the other. Ripple tank experiments show the interference patterns are strongest when the amplitude of the waves from each source is equal.

A similar interference occurs in sound systems when a signal is delayed and mixed back into the original signal. These interference patterns are called COMB FILTERS because their frequency response plots look like the teeth of a comb (see Figs. 1 & 2). There are a number of common situations that cause comb filters. For example, when the program is played through two loudspeakers, the loudspeaker that is farther away interferes with the closer loudspeaker. Comb filters are also created when a performer is picked up by two microphones, one closer than the other. You even introduce comb filters by mixing digital effects back into the "dry" signal at the mixer's effects loop.

Fig. 1:
COMB FILTERS. Input signal mixed with a 2 msec. delayed signal. (Both signals have the same amplitude. Max. filter gain is +6dB, and max. depth is $-\infty$.)

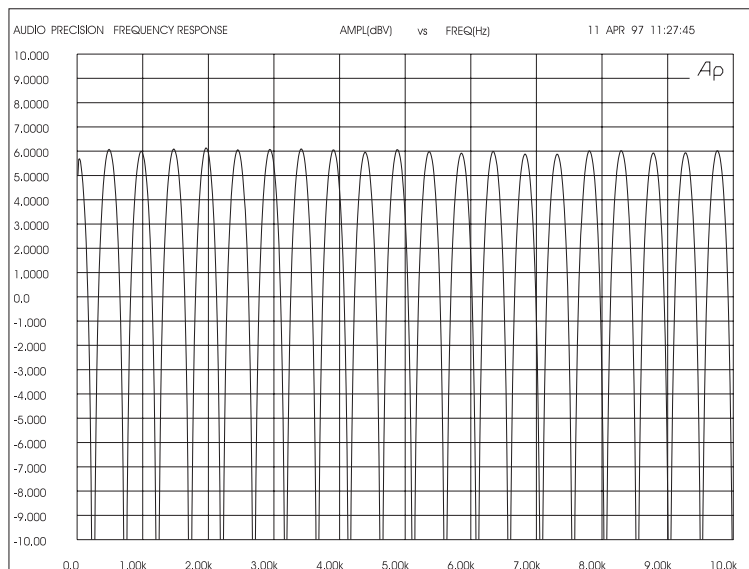

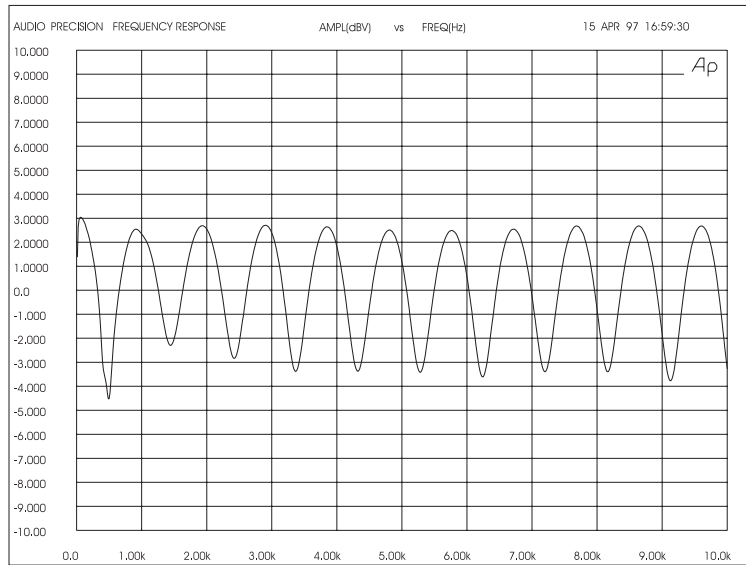

Fig. 2:
COMB FILTERS. Input signal mixed with a 2 msec. delayed signal. (Delayed signal has 10dB less amplitude. Max. filter gain is +2.5dB, and max. depth is -3.) Reducing the amplitude of the delayed signal reduces the comb filters' effect.

Calculating Comb Filter Frequencies

The frequencies of the reinforcements and cancellations depend on the delay time (the time difference between the arrival time of the original signal and the delayed signal). The frequency of the first cancellation occurs at $1/(2 \times t)$ Hz, where t = the delay time in seconds. The cancellations are separated by $(1/t)$ Hz. Fig. 3 shows how the comb filters change with the delay time.

Delay time = 0.002 sec.		Delay time = 0.003 sec.		Delay time = 0.004 sec.	
Cancellation Freq. (Hz)	Reinforcement Freq. (Hz)	Cancellation Freq. (Hz)	Reinforcement Freq. (Hz)	Cancellation Freq. (Hz)	Reinforcement Freq. (Hz)
250	500	167	333	125	250
750	1000	500	667	375	500
1250	1500	833	1000	625	750
1750	2000	1167	1333	875	1000
2250	2500	1500	1667	1125	1250
2750	3000	1833	2000	1375	1500
3250	3500	2167	2333	1625	1750
3750	4000	2500	2667	1875	2000
4250	4500	2833	3000	2125	2250

Fig. 3:
 Comb filters get closer as delay time increases.

Comb Filter Amplitude

If the original signal and the delayed signal are the same amplitude, the reinforced frequencies increase in amplitude by 6dB, while the out-of-phase frequencies cancel completely to $-\infty$ dB.

Comb filters cause a lot of problems. The frequencies that are reinforced are prone to excite feedback, while the out-of-phase cancellations make the program sound thin and over equalized.

Try this simple experiment to hear what comb filters do to your sound.

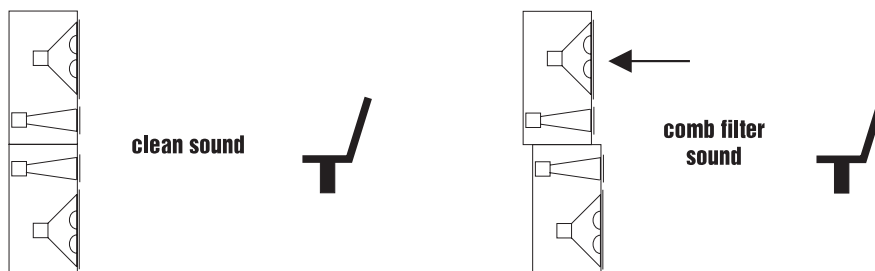

Fig. 4:
 Comb filters noticeably affect your sound.

Stack two identical full-range loudspeakers as shown in Fig. 4. Carefully align the HF horns and wire the speakers in mono. Stand in front while listening to your favorite full-spectrum CD. Ask a friend to move the top speaker slowly away from you. The degradation in sound quality you hear is caused by comb filters. The experiment is most dramatic when you use good quality speakers.

Correcting Comb Filters

Comb filters are inevitable to some degree in every live sound system, and they cannot be corrected with equalization. Fortunately, most comb filter problems can be reduced to a minimum by synchronizing the signals and reducing the amplitude of the delayed signal. The examples below show several practical applications.

The Precedence Effect: Aligning the Acoustic Image

Helmut Haas published a study in 1951 describing a series of experiments that demonstrates how people perceive delayed signals and echoes. In his experiments, a listener was positioned between two speakers placed 3 meters away; one was placed 45 degrees to the right and the other was placed 45 degrees to the left. When the same program was played through both speakers simultaneously, the listener perceived the acoustic image (the direction from which the sound seemed to be coming) centered between the speakers.

When Haas delayed the signal going to one of the speakers by somewhere between 5 to 35 milliseconds, the listener perceived a shift in the acoustic image to the speaker heard first. While the delayed speaker did not contribute to the apparent direction of the sound, it did make the program seem louder and “fuller.”

Haas showed that you must increase the loudness of the delayed signal by about 8 to 10 dB (twice the perceived loudness) in order for the acoustic image to move back to the original center position. Increasing the loudness more than this, or increasing the delay somewhat more than 35 milliseconds, makes the delayed signal sound like an echo.

The phenomenon describing how the acoustic image follows the signal we hear first is called the Precedence Effect. The phenomenon that makes two distinct sounds heard less than 35 msec. apart seem like only one sound is called the Haas Effect. However, the terms are often used interchangeably in the sound industry.

THREE APPLICATIONS

APPLICATION I: Under-The-Balcony Speakers

Fig. 5:
Overhead view
of under-balcony
application.

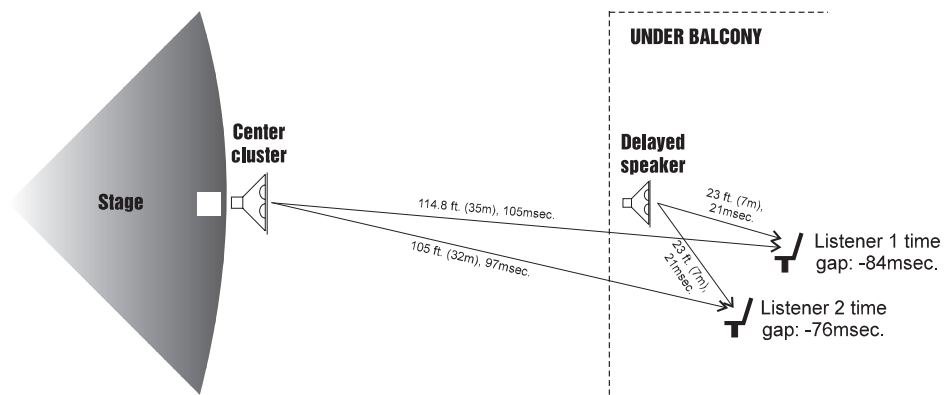

Fig. 5 above shows a typical situation where the performer is amplified by a center cluster hanging above the stage. Almost everybody in the audience will enjoy good sound, except those seated in the shadow of the balcony. So we add an under-balcony speaker to fill in the shadow.

.....

Now we have sufficient volume under the balcony, but the sound from the two speakers arrives at the listener's ears some 76 to 84 milliseconds apart. The two signals, along with their echoes, result in an unintelligible cacophony. We must delay the sound from the under-balcony speaker to synchronize the signals. Do we set the SDA-102 delay to 76 or 84 milliseconds? Obviously, the geometry will not allow us to exactly synchronize every location under the balcony; we have to compromise.

First, you must consider the program type. For spoken word programs, you will produce the best intelligibility if the signals from the under-balcony speakers arrive within 10 msec. of the signals from the center cluster. Therefore we should set the delay to 84-86 msec. You can allow a little more reverberation for programs that are mostly music.

Next, we must eliminate comb filter distortion. Find the axis where the levels of the center cluster and under-balcony speaker are equal. (See "Comb Filter Distortion," p.4.) Use the SDA-102 to precisely synchronize the speakers along this axis to eliminate the most severe comb filters. Comb filters off the equal-level axis are much less of a problem since a louder signal is not affected very much by a weaker signal.

Finally, you can experiment with adding 5 to 10 milliseconds delay to both sets of speakers to enhance the Precedence Effect for the audience seated near the performer.

In the final analysis, every setting is a compromise, and your ear has to be the final judge. Check the sound in several different locations throughout the auditorium and correct the most severe irregularities.

Application II: Center Cluster with Front Fills

Fig. 6 below describes a typical application that has a stage with a microphone, a center cluster above the stage, and front fills in front of the stage. There must be thousands of installations throughout the world like this that "get by" without digital delays. But with the SDA-102, you can improve the intelligibility and add a new quality without ringing up any significant costs. Use the SDA-102 in this situation to align the visual image with the acoustic image. The program is much more enjoyable when the amplified sound seems to be originating with the performer, not the loudspeakers.

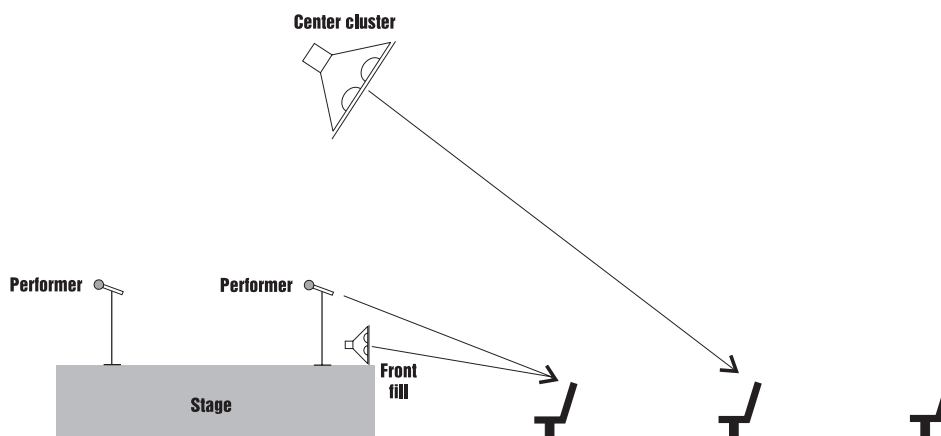

Fig. 6:
*Synchronizing
center clusters
and front fills.*

Find a central place in the audience where the center cluster is 6 to 8dB louder than the direct sound from the performer. Delay them so that their sound arrives 5 to 8 milliseconds after the direct sound from the performer. Experiment by bypassing the SDA-102 in and out to hear how the source of the sound seems to move from the loudspeakers to the performer and back. Now your ears have the same directional information as your eyes, so the performance will sound more natural and exciting. The best seats in the house just got better.

What about the front fills? Their purpose is to add intelligibility and listening comfort to the first few rows nearest the stage by filling in the areas missed by the center clusters. Simply

add about 8 msec. to the front fills to take advantage of the Precedence Effect.

The 8 msec. setting presumes the performer is standing on the front few feet of the stage. But some stages are well over 30 feet deep. What if there is a second performer standing 25 feet behind the first? The direct sound from his or her voice will reach the first few rows about 25 msec. after the first performer's. The audience will perceive the first performer directly and the second performer through the loudspeakers.

We can add the advantage of the Precedence Effect to the second performer by placing an SDA-102 in the mixer's channel insert point and adding a 25 msec. delay.

Certainly taking advantage of the Precedence Effect is not as obvious to the audience as eliminating feedback, but it is nice to know you did all that is possible to make the performance enjoyable.

Application III: Synchronizing the signals of a far-throw and short-throw loudspeaker.

In order to reach the proper coverage in larger venues, we often stack two full range speakers - a short-throw center cluster for the audience below and a far-throw speaker for the back of the auditorium. It is almost impossible to perfectly align the stacked speakers mechanically, so comb filter distortion becomes a problem in the area where the levels from both speakers are equal. The same thing happens with speakers mounted on the right and left sides.

Fig. 7:
Aligning far- and short-throw speakers. (The level from both speakers is equal.)

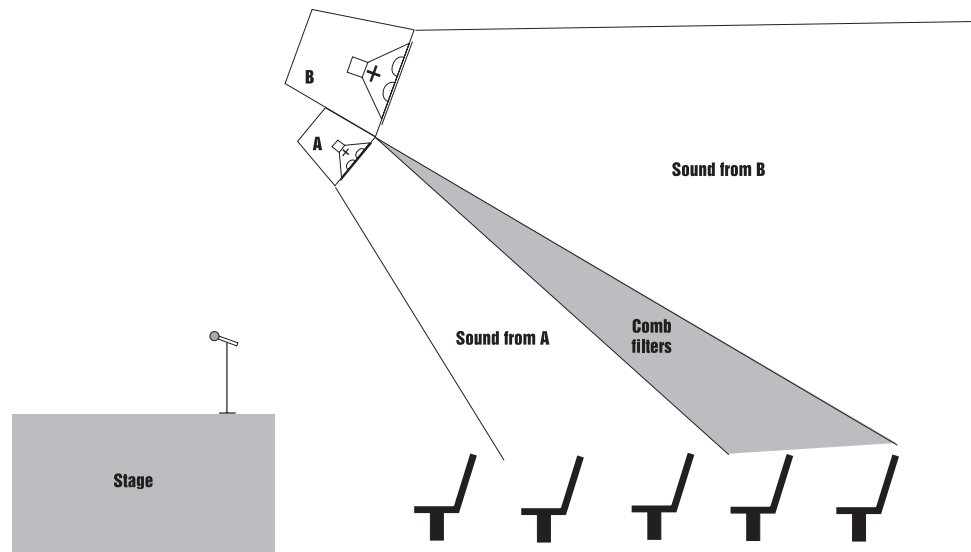

It is impossible to remove comb filters with equalization, but the SDA-102 eliminates them in short order without affecting the spectral balance for the rest of the audience. Find the axis where the levels from the two speakers are equal. This is where the comb filters are most severe. Carefully adjust the SDA-102 so that the signal from both speakers arrives at precisely the same time. The SDA provides 20 microsecond resolution for this purpose.

Use the same procedure to align speakers within a cluster when necessary.

CALCULATING DELAY TIME USING DISTANCE

Calculating delay time in terms of distance is a common and accepted method. For a good start, estimate the delay at 1 millisecond per foot between speakers. Use the following equation for more precise estimates:

$$\text{Delay (milliseconds)} = 1000 \left(\frac{D \text{ (distance in feet)}}{1130} \right)$$

OR

$$\text{Delay (milliseconds)} = 1000 \left(\frac{D \text{ (distance in meters)}}{344} \right)$$

These measurements presume standard temperature (68 degrees F, 20 degrees C) and pressure (29.2 in. Hg., 760 mm Hg.). Sound travels slower in cooler or drier air and at higher pressures. For example, the speed of sound decreases about 0.61 meters per second as the temperature drops from 20 degrees C to 0 degrees C.

BASIC OPERATING INSTRUCTIONS

The SDA-102 Instant Delay is designed for acoustical alignment of speaker systems only, not for use as an effect. Using the SDA for your speaker system fills will help the audience perceive the sound as originating on the stage, making the sound more natural.

Follow these operating instructions for best results.

1. Place the SDA between the mixer and the power amplifier - but after all signal processing equipment for the delayed speaker system. (*If you're using a Sabine FBX Feedback Exterminator, place the SDA after the FBX in the chain.*)
2. Make sure that the SDA is patched in correctly and that it is powered up. (When connecting the power supply to the SDA-102, angle the connector down, then push the connector up into the input **gently**, with the lip facing **up** as shown. Do not force the connector into or out of the SDA.) Play program material, and adjust the input level using a small flathead screwdriver until the red clip LED blinks intermittently during maximum program levels. (The red CLIP LED comes on when the input level is 6dB below clipping level.) Higher levels cause clipping and distortion, and lower levels introduce noise.
3. Adjust the output level for each channel individually, using a small screwdriver.
4. Press the A/B button to select channel A or B for setup. (The corresponding LED will light to indicate which channel is being set.) Enter the desired delay time (in milliseconds) using the up/down arrow keys.
5. If you want to lock out the front panel controls so the delay time can't be reprogrammed, set the lockout switch on the back panel to the DOWN position. (The factory default is in the UP position, which is UNLOCKED.)
6. The SDA's memory backup allows the last configuration to be stored in memory, so the delay time last programmed into the unit when it is powered down is the delay time that appears when the unit is powered up again.

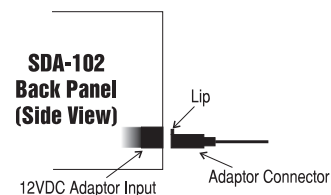

.....

ENGINEERING SPECIFICATIONS

PERFORMANCE

Frequency Response: +/- 0.5 dB @ +22 dBV, 20 Hz to 20 kHz
Dynamic Range: >100 dB
THD: <0.01% @ 22 dBV @ 1 kHz

DIGITAL RESOLUTION

20 bit A/D & D/A

DELAY RANGE

0.90 - 999.98 milliseconds

MINIMUM INCREMENT

20 microseconds for all display readings

DISPLAY

4 digit numeric LED
Millisecond display

DISPLAY RESOLUTION

0.90 - 99.98 milliseconds, 20 microseconds
100.0 - 999.9 milliseconds, 100 microseconds

FRONT PANEL LOCKOUT SWITCH

INPUT/OUTPUT

Input Impedance: Balanced >10 K Ohms, PIN 2 high
Output Impedance: Balanced 10 Ohms nominal, PIN 2 high
Input/Output Maximum Signal Levels: Balanced +26 dBV peak into 600 Ohms
Headroom: +22 dBV peak @ 4 dBV nominal input
I/O Connectors: Euroblock 3-pin

POWER INPUT

100, 117, 230 VAC +/-15%, 50/60 Hz, <12 Watt
Thermal fusing contained in wall mount transformer

DIMENSIONS

1-U height, 1/6-RU width; 2.78 x 1.65 x 5.5 in. (6.95 x 4.13 x 13.75 cm)
Weight: <2.0 lb.

OPTION

SL6RACK Rack Tray (holds up to six units)

SPECIFICATIONS SUBJECT TO CHANGE WITHOUT NOTICE.

FCC STATEMENT:

This device complies with Part 15, Class B, of the FCC Rules. Operation is subject to the following two conditions: (1) This device may not cause harmful interference; and (2) This device must accept any interference received, including interference that may cause undesired operation.



SAFETY INFORMATION

Warning! This equipment must be earthed.
 Caution! Risk of electric shock. Do not open.
 Caution! Shock hazard. Do not remove covers. No user serviceable parts inside. Refer servicing to qualified service personnel.
 Warning! To reduce the risk of fire or electric shock, do not expose this product to rain or moisture.

Attention! Cet appareil doit être relié à la terre.
 Attention! Risque de choc électrique; ne pas ouvrir.
 Attention! Risque de choc; ne pas oter les capots. Aucune pièce accessible à l'intérieur. S'adresser à un technicien qualifié.
 Attention! Pour réduire le risque d'incendie ou de choc électrique, ne pas laisser l'appareil sous la pluie ou à l'humidité.

Achtung! Dieses Gerät muss schutzgeerdet sein.
 Achtung! Gefahr eines elektrischen Stromschlags. Gehäuse nicht öffnen.
 Achtung! Gefahr eines elektrischen Stromschlags. Gehäuse nicht öffnen. Keine von Benutzer zu bedienenden Teile im Geräteinneren.
 Überlassen Sie das Gerät zu Servicezwecken nur geschultem Fachpersonal.
 Um Brandgefahr oder das Risiko eines elektrischen Schlags auszuschließen, das Gerät vor Nässe und Feuchtigkeit schützen.

Advertencia! Este equipo debe estar conectado a tierra.
 Precaución! Riesgo de descarga eléctrica. No abrir.
 Precaución! Riesgo de descarga eléctrica. No desmontar las tapas. Piezas interiores no reparables por el usuario. Reparable sólo por personal cualificado.
 Advertencia! Para reducir el riesgo de incendio o de descarga eléctrica no exponga este producto a la lluvia o humedad.

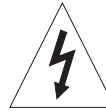

Warning!



The SDA-102 is designed to operate from standard AC power. Please be sure the power in your area is compatible with the power module accompanying the unit. Using the wrong input voltage may cause permanent damage to the unit and will void the warranty.

The SDA-102 is supplied with one of the following AC adapter modules:

Japan	100 VAC
U.S./North America	120 VAC
Continental Europe	230 VAC
United Kingdom	240 VAC
Australia	240 VAC

CAUTION:

EXPOSURE TO EXTREMELY HIGH NOISE LEVELS MAY CAUSE A PERMANENT HEARING LOSS. INDIVIDUALS VARY CONSIDERABLY IN SUSCEPTIBILITY TO NOISE INDUCED HEARING LOSS, BUT NEARLY EVERYONE WILL LOSE SOME HEARING IF EXPOSED TO SUFFICIENTLY INTENSE NOISE FOR A SUFFICIENT TIME. THE U.S. GOVERNMENT'S OCCUPATIONAL SAFETY AND HEALTH ADMINISTRATION (OSHA) HAS SPECIFIED THE FOLLOWING PERMISSIBLE NOISE LEVEL EXPOSURES:

DURATION/DAY IN HOURS	SOUND LEVEL in dBA, SLOW RESPONSE
8	90
6	92
4	95
3	97
2	100
1-1/2	102
1	105
1/2	110
1/4 or less	115

ACCORDING TO OSHA, ANY EXPOSURE IN EXCESS OF THE ABOVE PERMISSIBLE LIMITS COULD RESULT IN HEARING LOSS. EAR PLUGS OR PROTECTORS IN THE EAR CANALS OR OVER THE EARS MUST BE WORN WHEN OPERATING THIS DEVICE IN ORDER TO PREVENT A PERMANENT HEARING LOSS. IF EXPOSURE IS IN EXCESS OF THE LIMITS AS SET FORTH ABOVE, TO ENSURE AGAINST POTENTIALLY DANGEROUS EXPOSURE TO HIGH SOUND PRESSURE LEVELS, IT IS RECOMMENDED THAT ALL PERSONS EXPOSED TO EQUIPMENT CAPABLE OF PRODUCING HIGH SOUND PRESSURE LEVELS SUCH AS THIS DEVICE BE PROTECTED BY HEARING PROTECTORS WHILE THIS UNIT IS IN OPERATION.

1. Read all safety and operating instructions before using this product.
2. All safety and operating instructions should be retained for future reference.
3. Obey all cautions in the operating instructions and on the unit.
4. All operating instructions should be followed.
5. This product should not be used near water, i.e a bathtub, sink, swimming pool, wet basement, etc.
6. This product should be located so that its position does not interfere with its proper ventilation. It should not be placed flat against a wall or placed in a built-in enclosure that will impede the flow of cooling air.
7. This product should not be placed near a source of heat such as a stove or radiator.
8. Connect only to a power supply of the type marked on the unit adjacent to the power.
9. Never break off the ground pin on the power supply cord.
10. Power supply cords should always be handled carefully. Never walk or place equipment on power supply cords. Periodically check cords for cuts or signs of stress, especially at the plug and the point where the cord exits the unit.
11. The power supply cord should be unplugged when the unit is to be unused for long periods of time.
12. Care should be taken so that objects do not fall and liquids are not spilled into the unit through the ventilation holes or any other openings.
13. This unit should be checked by a qualified service technician if:
 - A. The power supply cord or plug has been damaged.
 - B. Anything has fallen or been spilled into the unit.
 - C. The unit does not operate correctly.
 - D. The unit has been dropped or the enclosure damaged.
14. The user should not attempt to service this equipment. All service work should be done by a qualified service technician.

OSHA 2201; 1995 revised.

.....

ONE-YEAR LIMITED WARRANTY:

THIS LIMITED WARRANTY VALID ONLY WHEN PURCHASED AND REGISTERED IN THE UNITED STATES OR CANADA. ALL EXPORTED PRODUCTS ARE SUBJECT TO WARRANTY AND SERVICES TO BE SPECIFIED AND PROVIDED BY THE AUTHORIZED DISTRIBUTOR FOR EACH COUNTRY.

Ces clauses de garantie ne sont valables qu'aux Etats-Unis et au Canada. Dans tous les autres pays, les clauses de garantie et de maintenance sont fixées par le distributeur national et assurées par lui selon la législation en vigueur.

Diese Garantie ist nur in den USA und Kanada gültig. Alle Export-Produkte sind der Garantie und dem Service des Importeurs des jeweiligen Landes unterworfen.

Esta garantía es válida solamente cuando el producto es comprado en E.U. continentales o en Canada. Todos los productos que sean comprados en el extranjero, están sujetos a las garantías y servicio que cada distribuidor autorizado determine y otorga en los diferentes países.

ONE-YEAR LIMITED WARRANTY/REMEDY

SABINE, INC. ("SABINE") warrants this product to be free from defects in material and workmanship for a period of one (1) year from date of purchase PROVIDED, however, that this limited warranty is extended only to the original retail purchaser and is subject to the conditions, exclusions and limitations hereinafter set forth:

CONDITIONS, EXCLUSIONS AND LIMITATIONS OF LIMITED WARRANTIES

These limited warranties shall be void and of no effect if:

- a. The first purchase of the product is for the purpose of resale; or
 - b. The original retail purchase is not made from an AUTHORIZED SABINE DEALER; or
 - c. The product has been damaged by accident or unreasonable use, neglect, improper service or maintenance, or other causes not arising out of defects in material or workmanship; or
 - d. The serial number affixed to the product is altered, defaced or removed; or
 - e. The power supply grounding pin is removed or otherwise defeated.
- In the event of a defect in material and/or workmanship covered by this limited warranty, Sabine will repair the defect in material or workmanship or replace the product, at Sabine's option; and provided, however, that, in any case, all costs of shipping, if necessary, are paid by you, the purchaser.

THE WARRANTY REGISTRATION CARD SHOULD BE ACCURATELY COMPLETED, MAILED TO AND RECEIVED BY SABINE WITHIN FOURTEEN (14) DAYS FROM THE DATE OF YOUR PURCHASE.

In order to obtain service under these warranties, you must:

- a. Bring the defective item to any AUTHORIZED SABINE DEALER and present therewith the ORIGINAL PROOF OF PURCHASE supplied to you by the AUTHORIZED SABINE DEALER in connection with your purchase from him of this product. If the DEALER is unable to provide the necessary warranty service, you will be directed to the nearest other SABINE AUTHORIZED DEALER which can provide such service.

OR

- b. Call Sabine for a RETURN AUTHORIZATION NUMBER and ship the defective item, prepaid, to:

SABINE, INC.
13301 HIGHWAY 441
ALACHUA, FL 32615-8544 USA

including therewith a complete, detailed description of the problem, together with a legible copy of the original PROOF OF PURCHASE and a complete return address. Upon Sabine's receipt of these items:

If the defect is remedial under the limited warranties and the other terms and conditions expressed have been complied with, Sabine will provide the necessary warranty service to repair or replace the product and will return it, FREIGHT COLLECT, to you, the purchaser. Sabine's liability to the purchaser for damages from any cause whatsoever and regardless of the form of action, including negligence, is limited to the actual damages

up to the greater of \$500.00 or an amount equal to the purchase price of the product that caused the damage or that is the subject of or is directly related to the cause of action. Such purchase price will be that in effect for the specific product when the cause of action arose. This limitation of liability will not apply to claims for personal injury or damage to real property or tangible personal property allegedly caused by Sabine's negligence. Sabine does not assume liability for personal injury or property damage arising out of or caused by a non-Sabine alteration or attachment, nor does Sabine assume any responsibility for damage to interconnected non-Sabine equipment that may result from the normal functioning and maintenance of the Sabine equipment.

UNDER NO CIRCUMSTANCES WILL SABINE BE LIABLE FOR ANY LOST PROFITS, LOST SAVINGS, ANY INCIDENTAL DAMAGES OR ANY CONSEQUENTIAL DAMAGES ARISING OUT OF THE USE OR INABILITY TO USE THE PRODUCT, EVEN IF SABINE HAS BEEN ADVISED OF THE POSSIBILITY OF SUCH DAMAGES.

THESE LIMITED WARRANTIES ARE IN LIEU OF ANY AND ALL WARRANTIES, EXPRESS OR IMPLIED, INCLUDING BUT NOT LIMITED TO, THE IMPLIED WARRANTIES OF MERCHANTABILITY AND FITNESS FOR A PARTICULAR USE; PROVIDED, HOWEVER, THAT IF THE OTHER TERMS AND CONDITIONS NECESSARY TO THE EXISTENCE OF THE EXPRESS LIMITED WARRANTIES, AS HEREINABOVE STATED, HAVE BEEN COMPLIED WITH, IMPLIED WARRANTIES ARE NOT DISCLAIMED DURING THE APPLICABLE ONE-YEAR PERIOD FROM DATE OF PURCHASE OF THIS PRODUCT.

SOME STATES DO NOT ALLOW LIMITATION ON HOW LONG AN IMPLIED WARRANTY LASTS, OR THE EXCLUSION OR LIMITATION OF INCIDENTAL OR CONSEQUENTIAL DAMAGES, SO THE ABOVE LIMITATIONS OR EXCLUSIONS MAY NOT APPLY TO YOU. THESE LIMITED WARRANTIES GIVE YOU SPECIFIC LEGAL RIGHTS, AND YOU MAY ALSO HAVE OTHER RIGHTS WHICH MAY VARY FROM STATE TO STATE.

THESE LIMITED WARRANTIES ARE THE ONLY EXPRESS WARRANTIES ON THIS PRODUCT, AND NO OTHER STATEMENT, REPRESENTATION, WARRANTY OR AGREEMENT BY ANY PERSON SHALL BE VALID OR BINDING UPON SABINE.

In the event of any modification or disclaimer of express or implied warranties, or any limitation of remedies, contained herein conflicts with applicable law, then such modification, disclaimer or limitation, as the case may be, shall be deemed to be modified to the extent necessary to comply with such law.

Your remedies for breach of these warranties are limited to those remedies provided herein, and Sabine gives this limited warranty only with respect to equipment purchased in the United States of America.

INSTRUCTIONS-WARRANTY REGISTRATION CARD

1. Mail the completed WARRANTY REGISTRATION CARD to:

SABINE, INC.
13301 HIGHWAY 441
ALACHUA, FL 32615-8544 USA

- a. Keep the PROOF OF PURCHASE. In the event warranty service is required during the warranty period, you will need this document. **There will be no identification card issued by Sabine, Inc.**

2. IMPORTANCE OF WARRANTY REGISTRATION CARDS AND NOTIFICATION OF CHANGES OF ADDRESS:

- a. Completion and mailing of WARRANTY REGISTRATION CARDS - Should notification become necessary for any condition that may require correction, the REGISTRATION CARD will help ensure that you are contacted and properly notified.

- b. Notice of address changes - If you move from the address shown on the WARRANTY REGISTRATION CARD, you should notify Sabine of the change of address so as to facilitate your receipt of any bulletins or other forms of notification which may become necessary in connection with any condition that may require dissemination of information or correction.

3. You may contact Sabine directly by telephoning (904) 418-2000.

4. Please have the Sabine product name and serial number available when communicating with Sabine Customer Service.

MADE IN USA.

Manufactured by: Sabine, Inc. • 13301 Highway 441 • Alachua, FL 32615-8544 USA •
Phone: (904) 418-2000 • Fax: (904) 418-2001 • www.sabine.com

SABINE[®]
ADAPTIVE AUDIO

4/10/97

00.12.13 - hto